

2024

## EXODOOR AUTOMATIC SLIDING DOOR BD-250 MODEL INSTALLATION GUIDE



İMAJ YAPI OTO.SİST.SAN VE TİC.LTD.ŞTİ.

Seyrantepe Mh. İbrahim Karaođlanođlu Cd.No:55 34418 KAđITHANE / İSTANBUL

Tel: 0212 270 00 44-45 - [www.exodoor.com.tr](http://www.exodoor.com.tr) – [info@exodoor.com.tr](mailto:info@exodoor.com.tr)

## BD-250 CONTROL UNIT

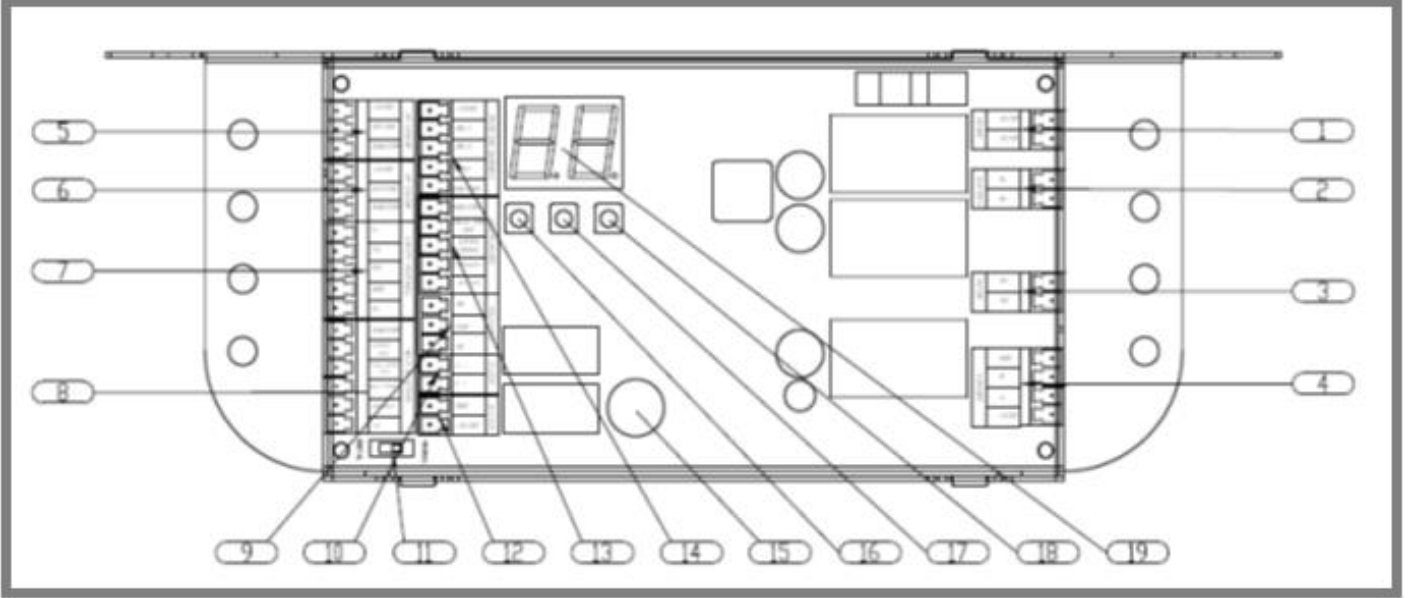

NO	FIRST NAME	EXPLANATION	FEATURESDAH
1	FEED	18,5 VAC / 27,5 VDC	TRANSFORMER / SMPS
2	BATTERY	2x12 V 1,3A	DRY TYPE BATTERY
3	ENGINE	24V 100W PMDC 1:15 REDUCER	DUNKER / OTHER
4	ENKODER	100 Puls	A-B ÇİFT KANAL
5	INTERNAL SENSOR	INTERNAL SENSOR	+12V - SIGNAL - GND
6	EXTERNAL SENSOR	EXTERNAL SENSOR	+12V - SIGNAL - GND
7	INTERNAL PHOTOCELL	INTERNAL POINT PHOTOCELL INPUT	
8	POSITION SWITCH	PROGRAM KEY ENTRY	
9	RELAY	CONTACT OUTPUT	NO – NC CONTACT
10	ELECTRONIC LOCK	LOCK OUTPUT	24 VDC MAGMET SYSTEM
11	MANUAL / DIGITAL	ELECTION SWITCH	
12	POWER OUTPUT	EKSTRA OUTPUT	TO OPERATE AN EXTERNAL DEVICE 24 VDC- GND
13	FEATURES	OPTIONS	EMERGENCY STOP EXTERNAL SIGNAL AIRLOCK-BREAKOUT PUSH ON-PRESS CLOSE SIGNAL INPUTS
14	BARRIER PHOTOCELL	EN16005 SIGNAL INPUTS	BEHIND THE WING OPENING DIRECTION SAFETY SENSOR INPUT
15	BUZZER	SIGNAL AUDIO OUTPUT	SOUND WARNING
16	(+)	INCREASING	
17	ELECTION	SELECK AND CONFIRM BUTTON	
18	(-)	DECREASE	
19	7 SEGMENT DISPLAY	DUAL SEGMET INDICATOR	

**İMAJ YAPI OTO.SİST.SAN VE TİC.LTD.ŞTİ.**

Tel. : 0212 270 00 44-45 - [www.exodoor.com.tr](http://www.exodoor.com.tr) – [info@exodoor.com.tr](mailto:info@exodoor.com.tr)

## BD-250 TECHNICAL SPECIFICATIONS

<b>System Brand</b>	: EXODOOR®
<b>Model</b>	: BD-250
<b>Engine</b>	: 24V 100W PMDC 1:15 Redüktör 100 Puls Dual Channel Encoder
<b>Elektronik Kontrol Ünitesi</b>	: Mikroprosesör 32 bit 48mhz 32 kHz pwm Exit. Pid Algorithm Motor Speed Control, Adjustable via 7 Segment Display Card. Manual - Digital - Remote Control Position Switches Connectivity, Air-lock-Breakout -Signal Close-Fire Signal Inputs, Internal Point Photocell External Photocell Input, Curtain Photocell Connectivity Opening Zone Safety Photocell Connectability, Automatic Weight and Distance Recognition, Ac-Dc Feeding Alternative, Battery Input and Charging Feature, Electromechanical Lock Connection, External 24 VDC Role Output Feature,
<b>Capacity</b>	: 150 kg x 1 (single wing) - 125 kg x 2 (double wing)
<b>Movement</b>	: On reinforced plastic (Derlin) wheels,
<b>Tranction</b>	: Timing belt
<b>Wheels</b>	: 3 Wheel System, Specially Designed Wearproof Material. (2 pieces with a diameter of 55mm at the bottom - 1 piece with a diameter of 40mm at the top)
<b>Opening Speed</b>	: 15 - 65 cm / s (single wing) - 15 - 55 cm / s (double wing)
<b>Closing Speed</b>	: 10 - 45 cm / s (single wing) - 10 - 43 cm / s (double wing)
<b>Opening Time</b>	: 0 -30 seconds (adjustable)
<b>Feed</b>	: 100-240 VAC—27,5VDC 6,5A SMPS
<b>Maximum Current Drawn</b>	: 6.5 A
<b>Working in emergencies</b>	: Battery (Optional) 2x12 V 1.3A Dry Type Battery Kit
<b>Location Features</b>	: PROGRAMMER WITH GRAPHICS DISPLAY (OPTIONAL) 128 x 64 Pixel Graphic Display Communication with Modbus Serial Communication, Full with Processor Synchronous Surface Mounting, Signal Monitoring, 7 Different Mode Options All Ability to Adjust Processor Settings, Key Lock Error Codes with Explanations Turkish-English Menu Option.
<b>Degree of Protection</b>	: IP 22
<b>Electronic Lock</b>	: Two-Way Usage with 24 Vdc Holder Magnet
<b>Mechanism Dimensions</b>	: Mechanism Height: 8 cm Mechanism Cover Height: 12 cm Mechanism Depth: 15.5 cm
<b>Internal Photocell</b>	: 1 Receiver 1 Transmitter 38khz Receiver Transmitter 2.5 m Quaxial Cable.
<b>Multiplication Functions</b>	: When it hits any obstacle, the system activates and turns it back on.
<b>Operating temperature</b>	: -20° C / + 55° C
<b>European Standards Certification</b>	: CE -EN 16005 - İSO 9001-2015 - TSE-HYB

İMAJ YAPI OTO.SİST.SAN VE TİC.LTD.ŞTİ.

Tel. : 0212 270 00 44-45 - [www.exodoor.com.tr](http://www.exodoor.com.tr) – [info@exodoor.com.tr](mailto:info@exodoor.com.tr)

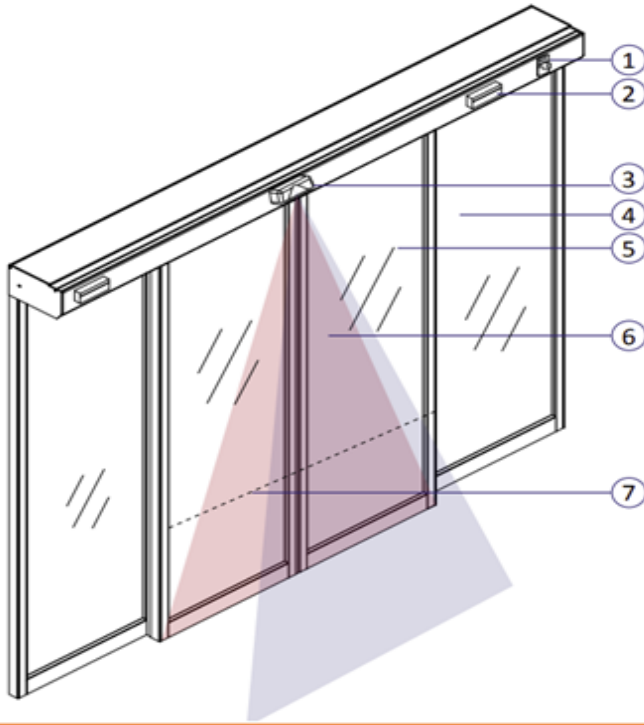

- 1) **Position Switch:** Used to change the operating modes of the door.
- 2) **Protection Sensor:** It is used to prevent jamming in the opening directions of moving wings. (OPTIONAL)
- 3) **Radar:** Allows the door to be opened when it detects movement.
- 4) **Fixed Wing:** These are fixed windows on the profile that do not move.
- 5) **Movable Wing:** It is the wing that provides movement depending on the mechanism.
- 6) **Detection Area:** Distance can be adjusted via radar.
- 7) **Safety Photocell:** It is used to prevent jamming between moving wings.

## CONNECTION DIAGRAM

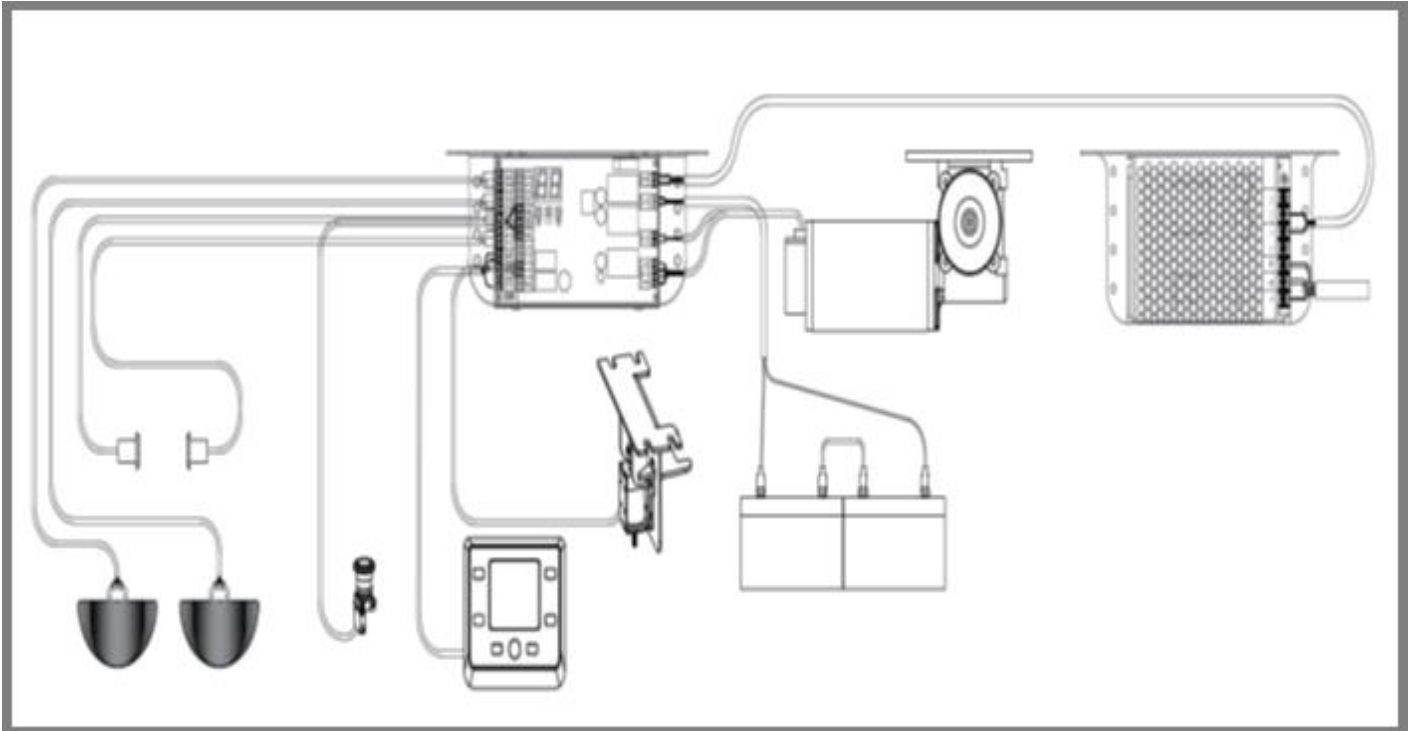

**İMAJ YAPI OTO.SİST.SAN VE TİC.LTD.ŞTİ.**

Tel. : 0212 270 00 44-45 - [www.exodoor.com.tr](http://www.exodoor.com.tr) – [info@exodoor.com.tr](mailto:info@exodoor.com.tr)

## RADAR CONNECTION

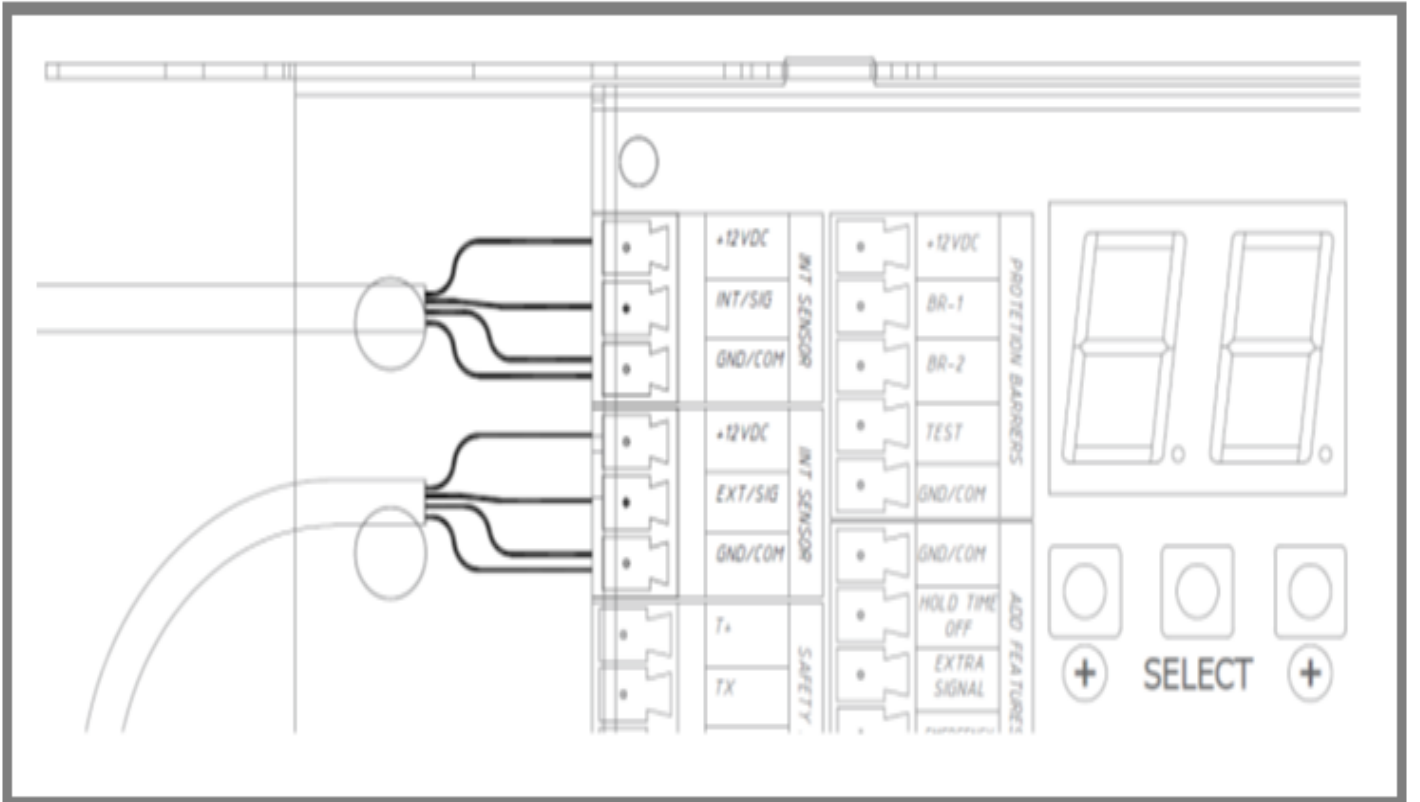
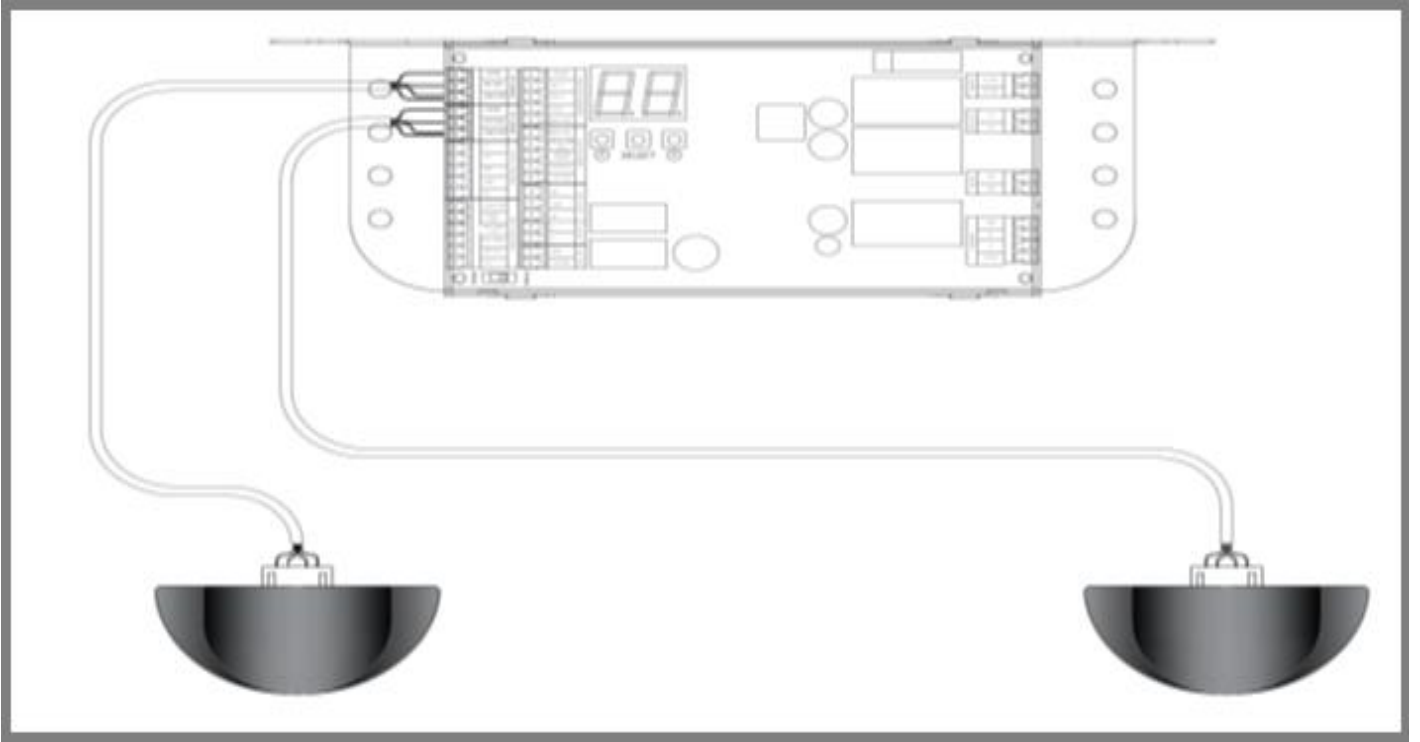

İMAJ YAPI OTO.SİST.SAN VE TİC.LTD.ŞTİ.

Tel. : 0212 270 00 44-45 - [www.exodoor.com.tr](http://www.exodoor.com.tr) – [info@exodoor.com.tr](mailto:info@exodoor.com.tr)

## SAFETY PHOTOCELL CONNECTION

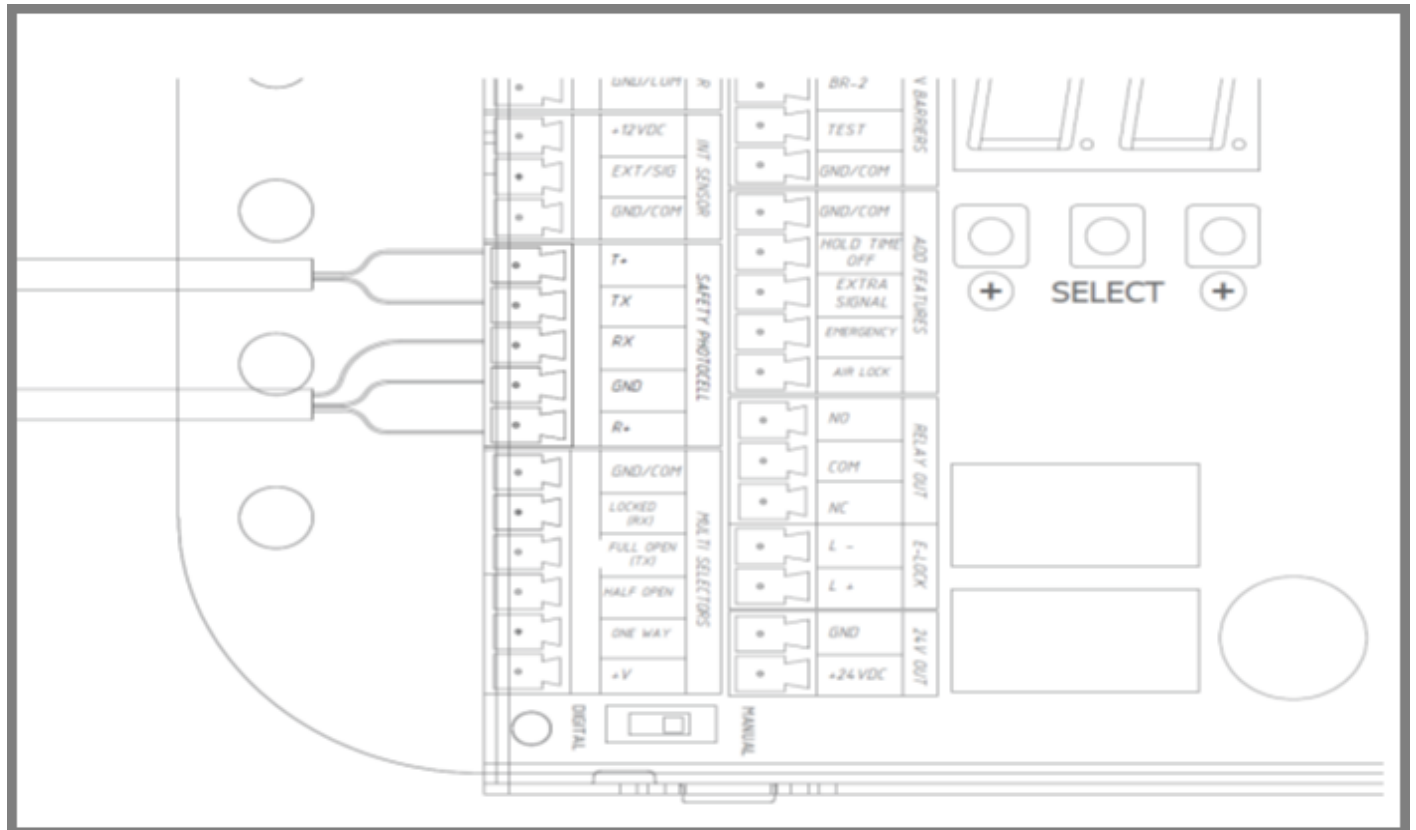
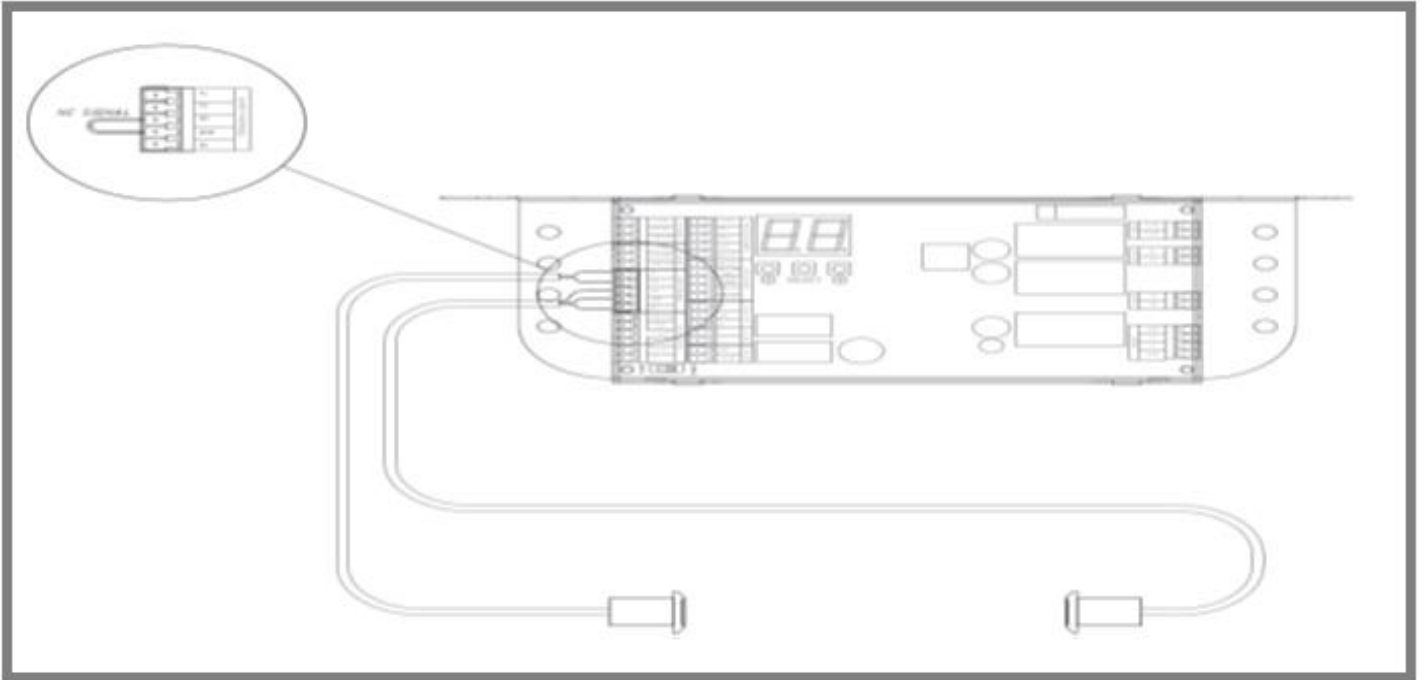

**İMAJ YAPI OTO.SİST.SAN VE TİC.LTD.ŞTİ.**

Tel. : 0212 270 00 44-45 - [www.exodoor.com.tr](http://www.exodoor.com.tr) – [info@exodoor.com.tr](mailto:info@exodoor.com.tr)

## DIGITAL POSITION SWITCH CONNECTION

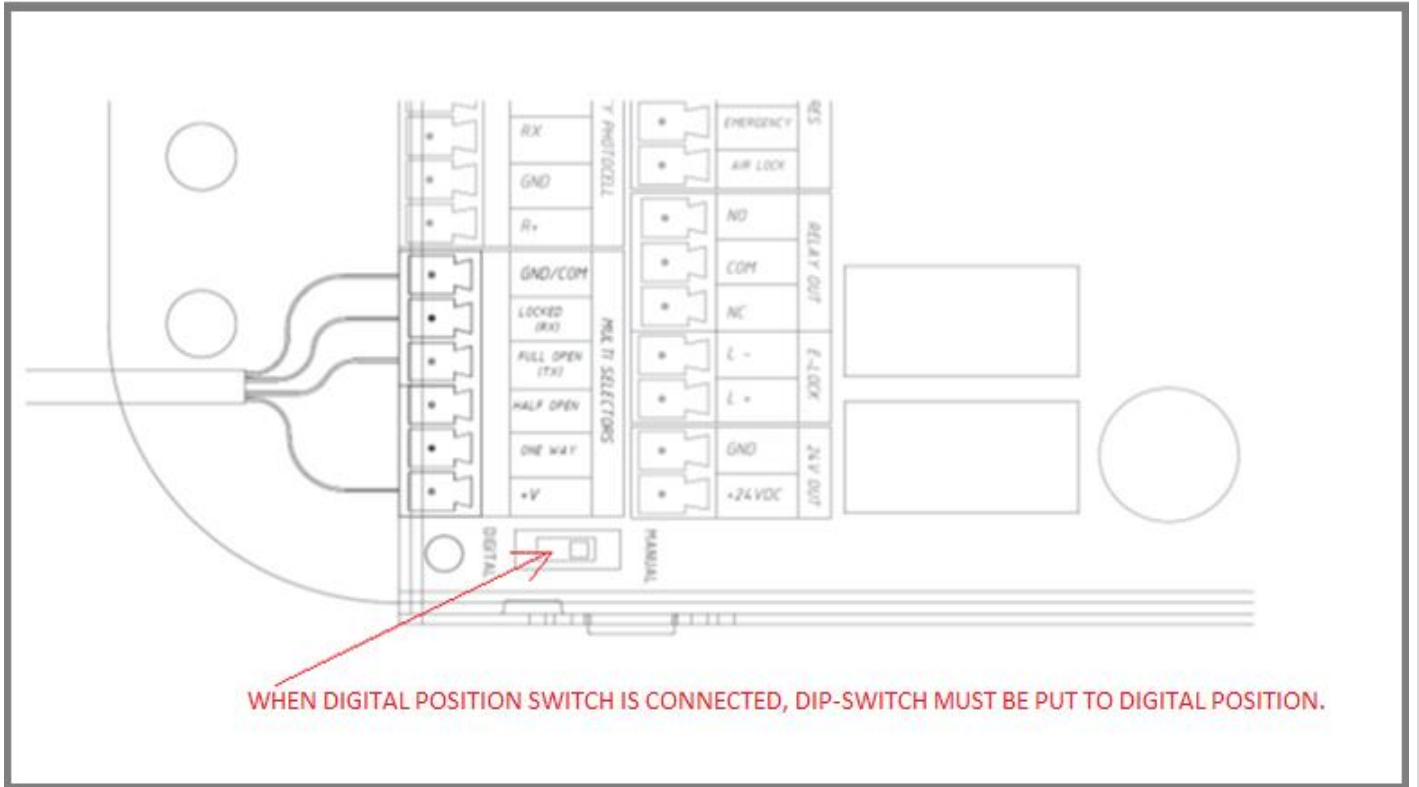
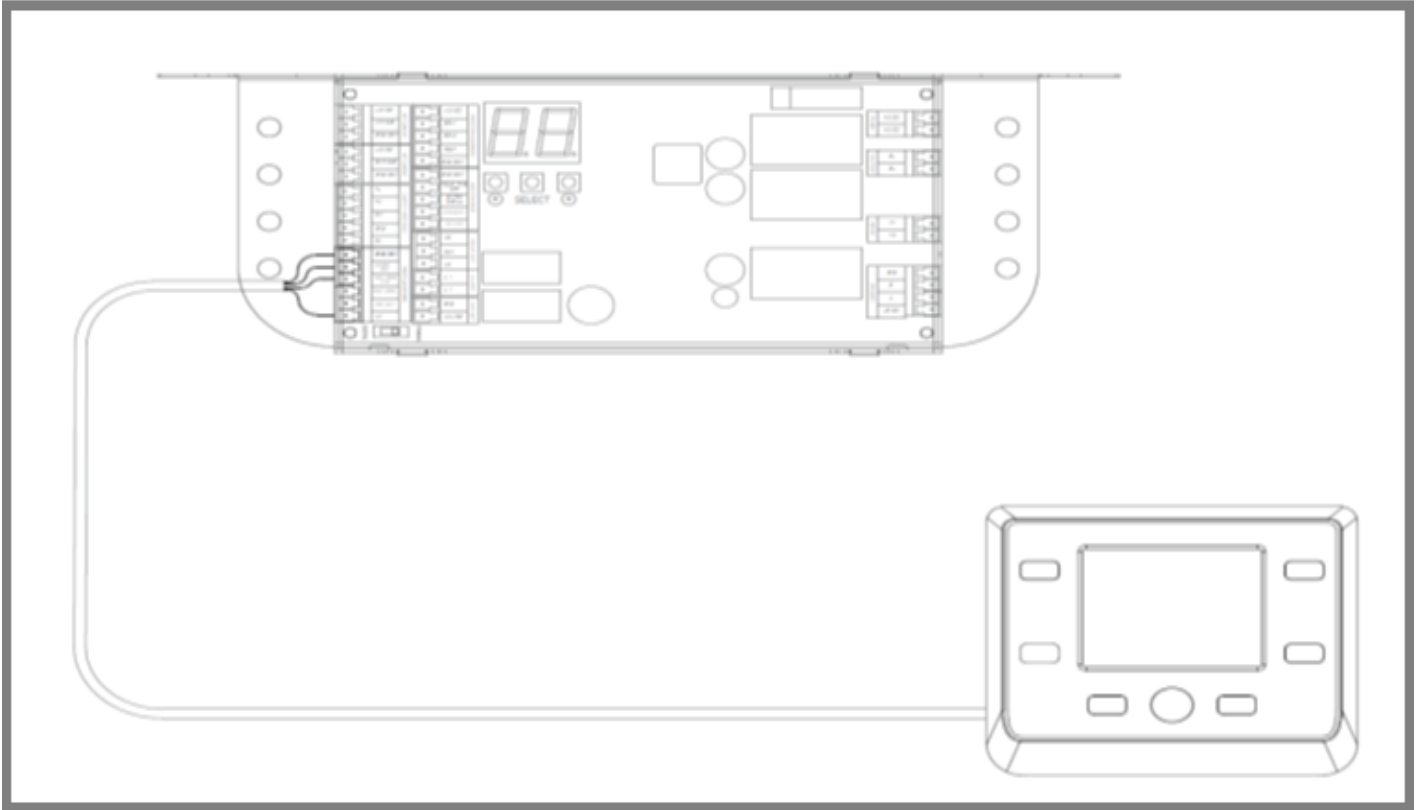

**İMAJ YAPI OTO.SİST.SAN VE TİC.LTD.ŞTİ.**

Tel. : 0212 270 00 44-45 - [www.exodoor.com.tr](http://www.exodoor.com.tr) – [info@exodoor.com.tr](mailto:info@exodoor.com.tr)

## MANUAL POSITION SWITCH CONNECTION

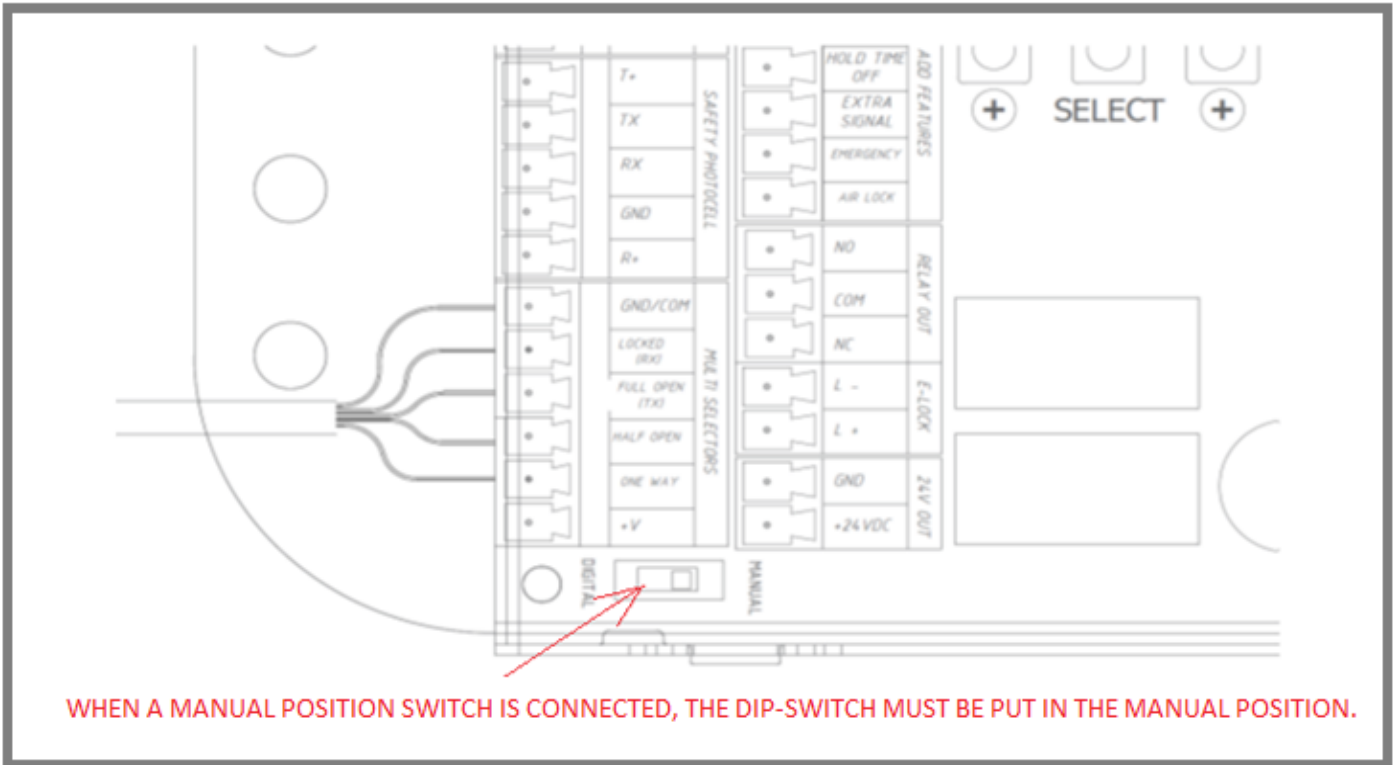
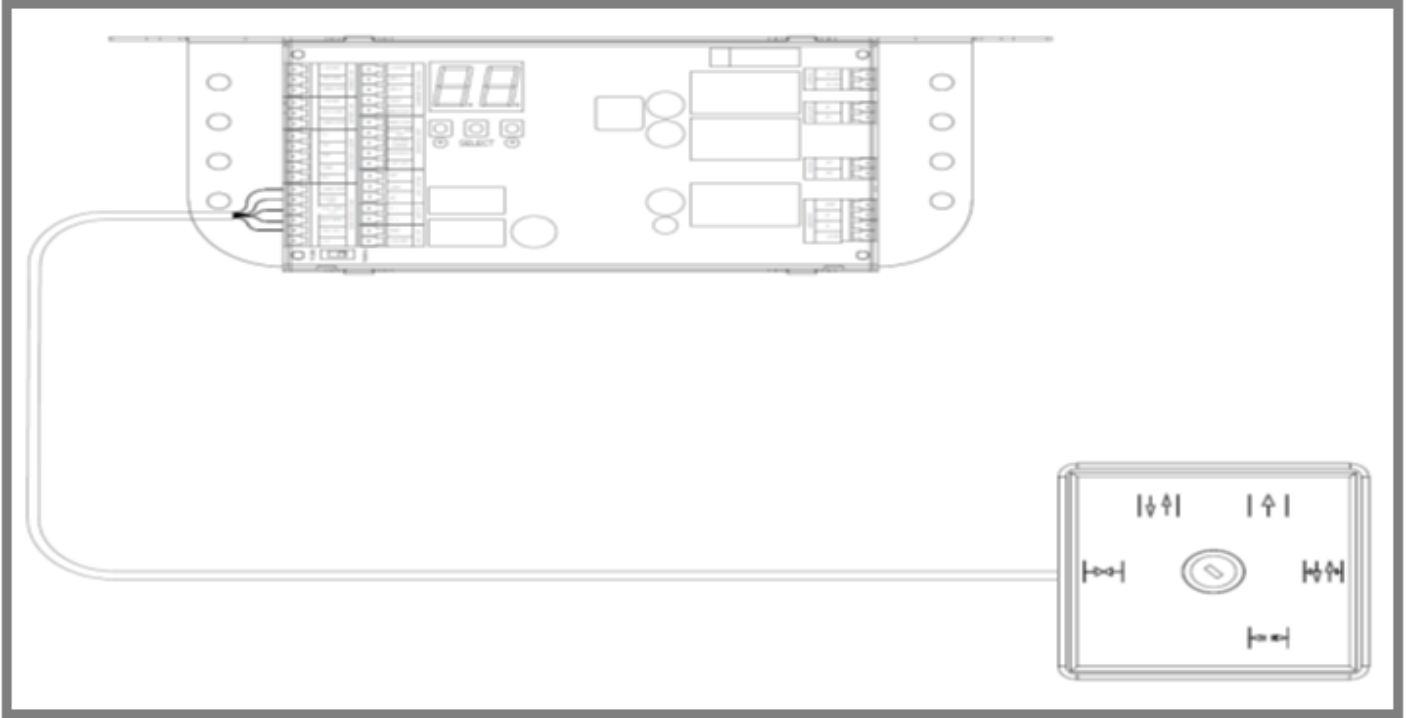

İMAJ YAPI OTO.SİST.SAN VE TİC.LTD.ŞTİ.

Tel. : 0212 270 00 44-45 - [www.exodoor.com.tr](http://www.exodoor.com.tr) – [info@exodoor.com.tr](mailto:info@exodoor.com.tr)



## ENGINE CONNECTION

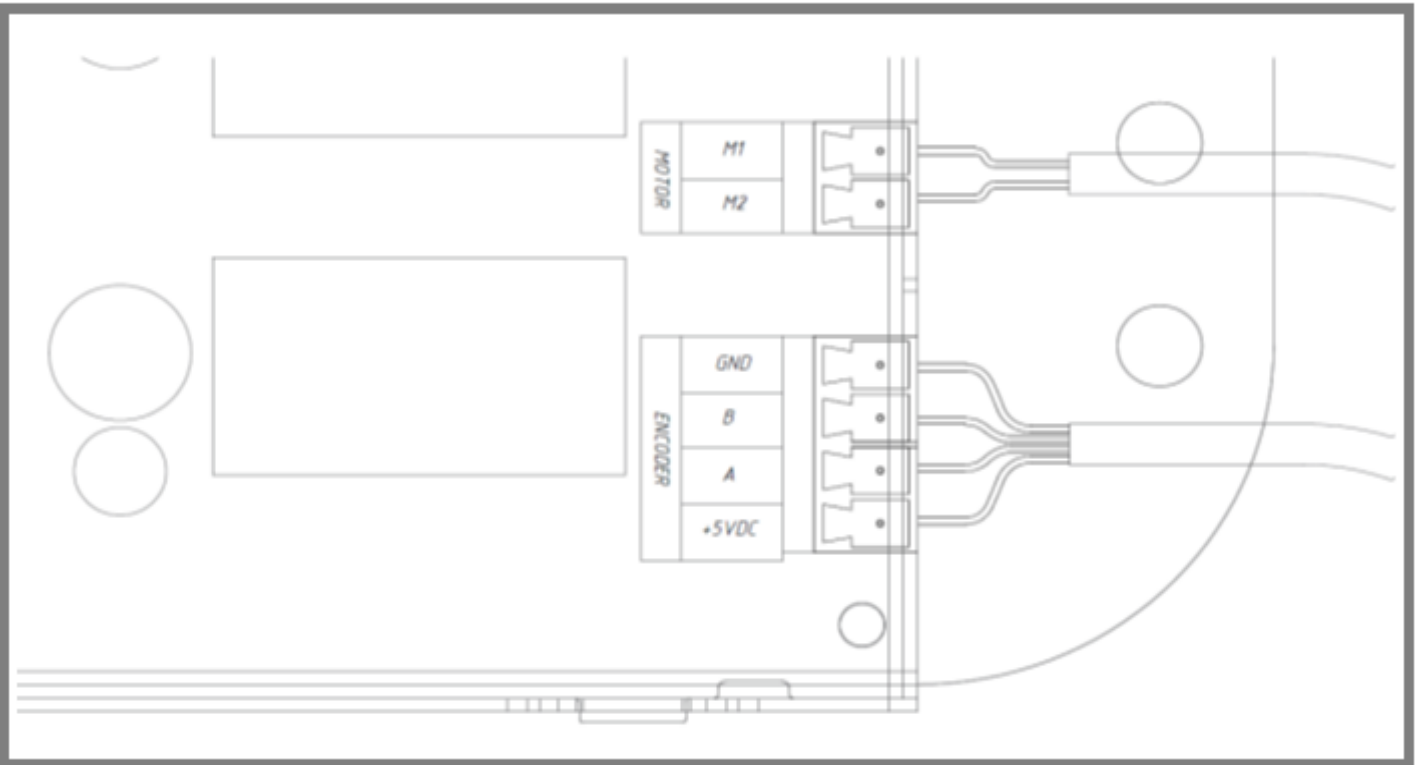
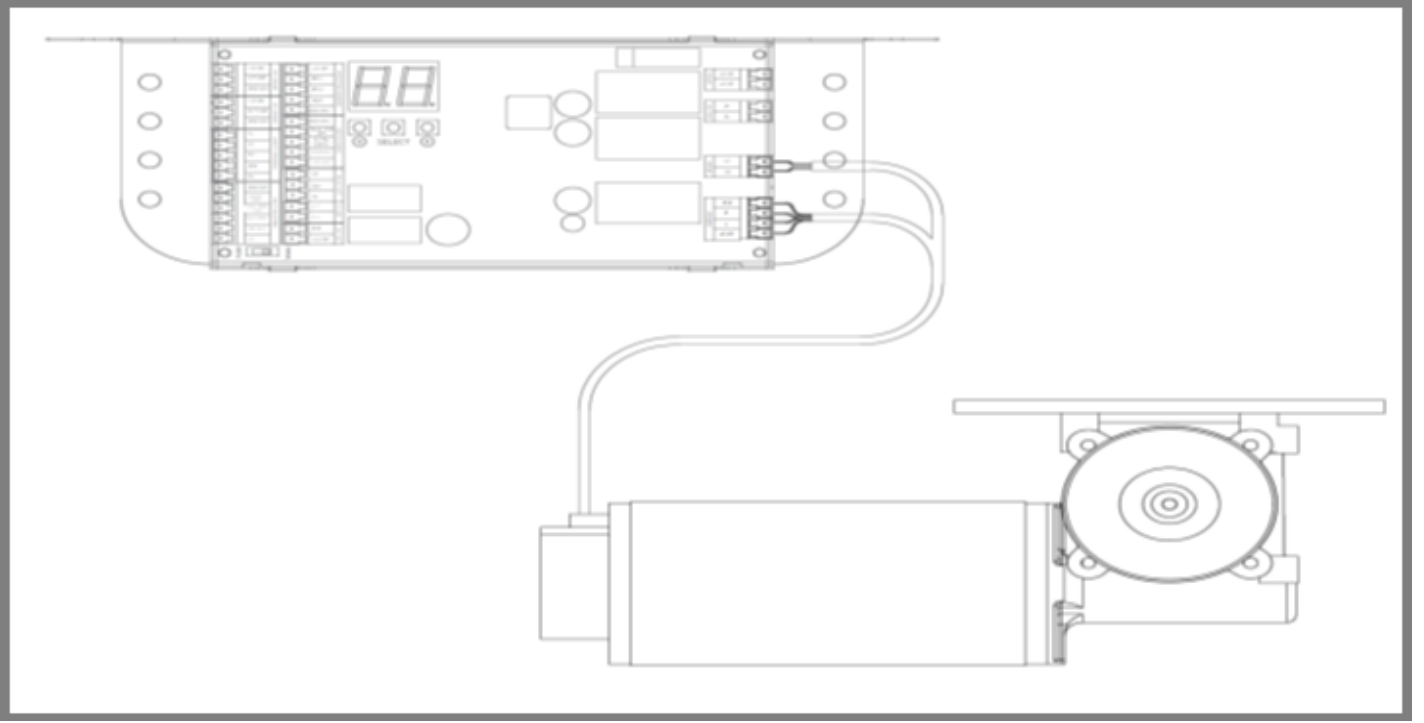

İMAJ YAPI OTO.SİST.SAN VE TİC.LTD.ŞTİ.

Tel. : 0212 270 00 44-45 - [www.exodoor.com.tr](http://www.exodoor.com.tr) – [info@exodoor.com.tr](mailto:info@exodoor.com.tr)

## SMPS CONNECTION

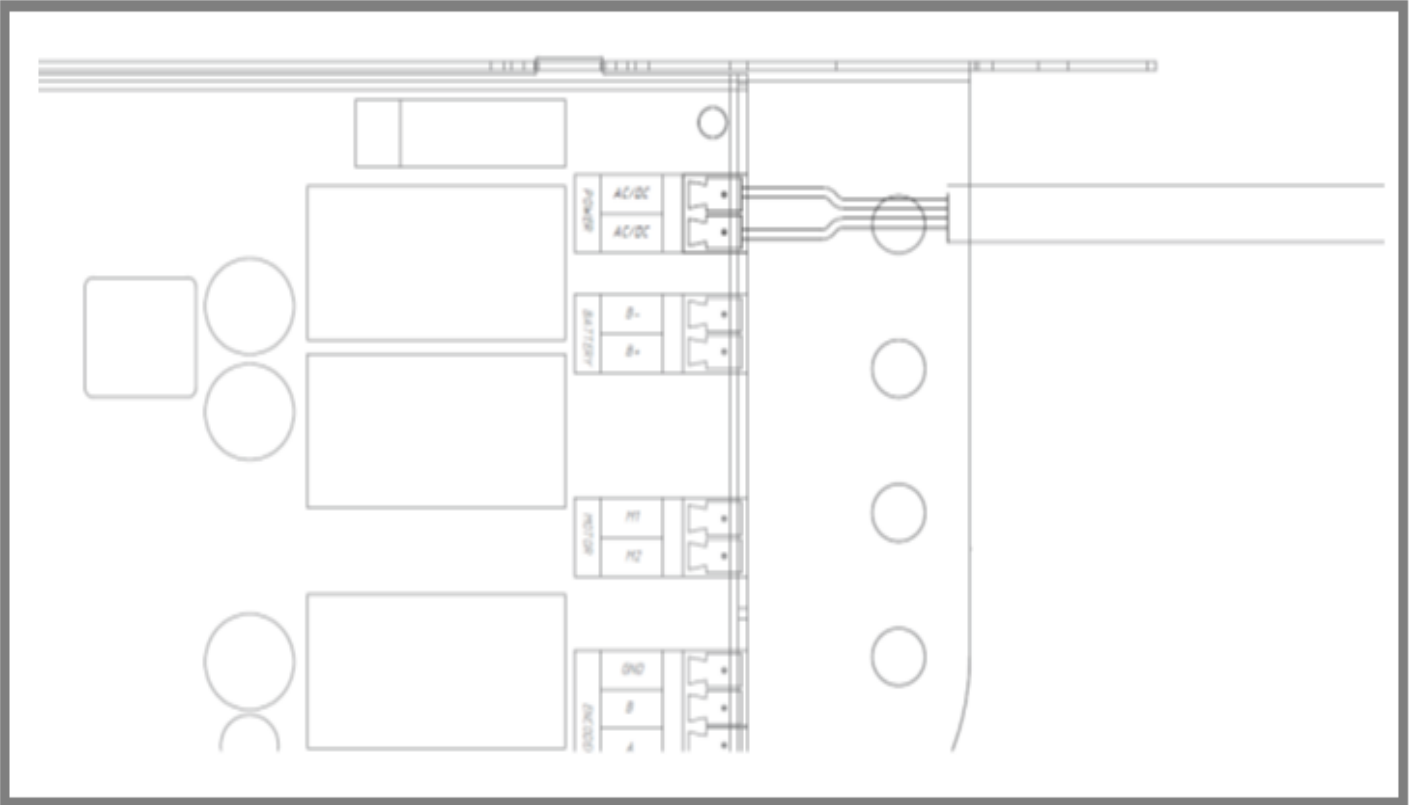
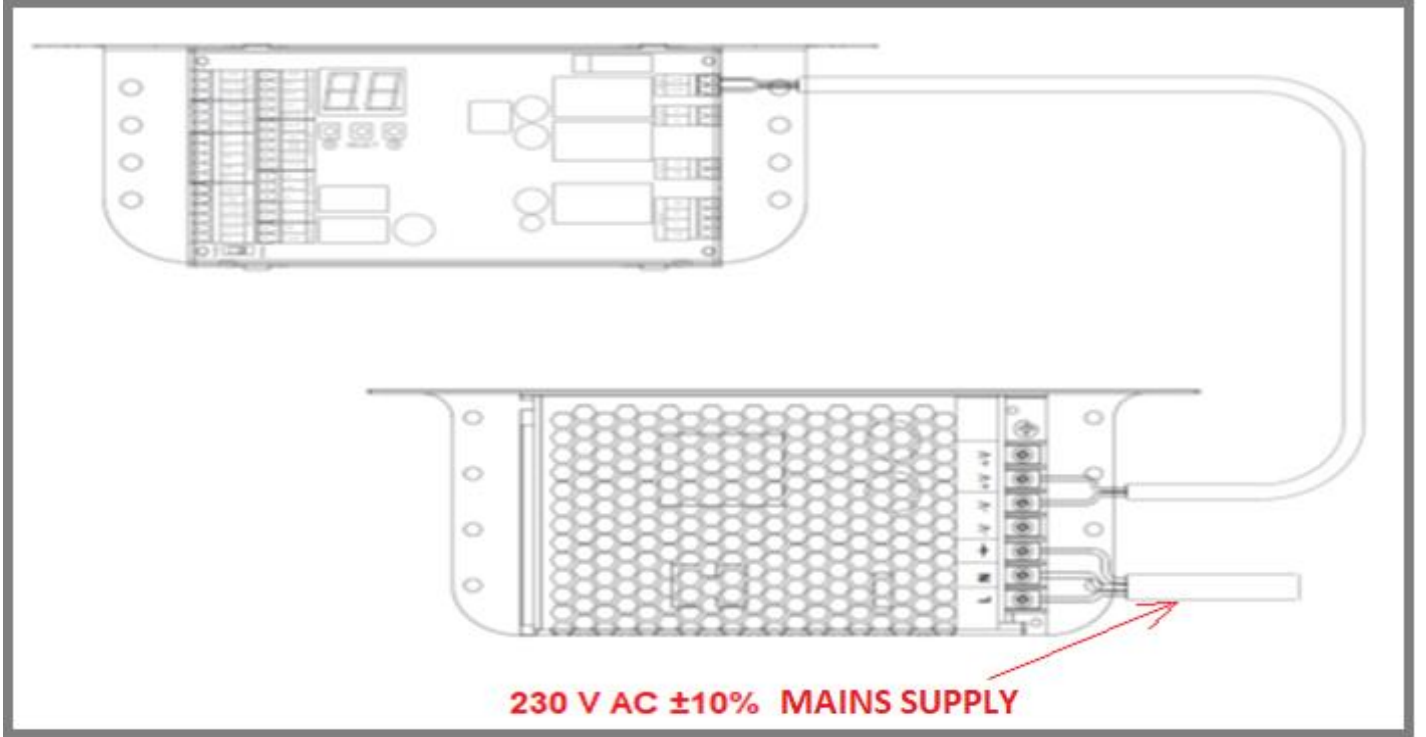

İMAJ YAPI OTO.SİST.SAN VE TİC.LTD.ŞTİ.

Tel. : 0212 270 00 44-45 - [www.exodoor.com.tr](http://www.exodoor.com.tr) - [info@exodoor.com.tr](mailto:info@exodoor.com.tr)

## BATTERY CONNECTION

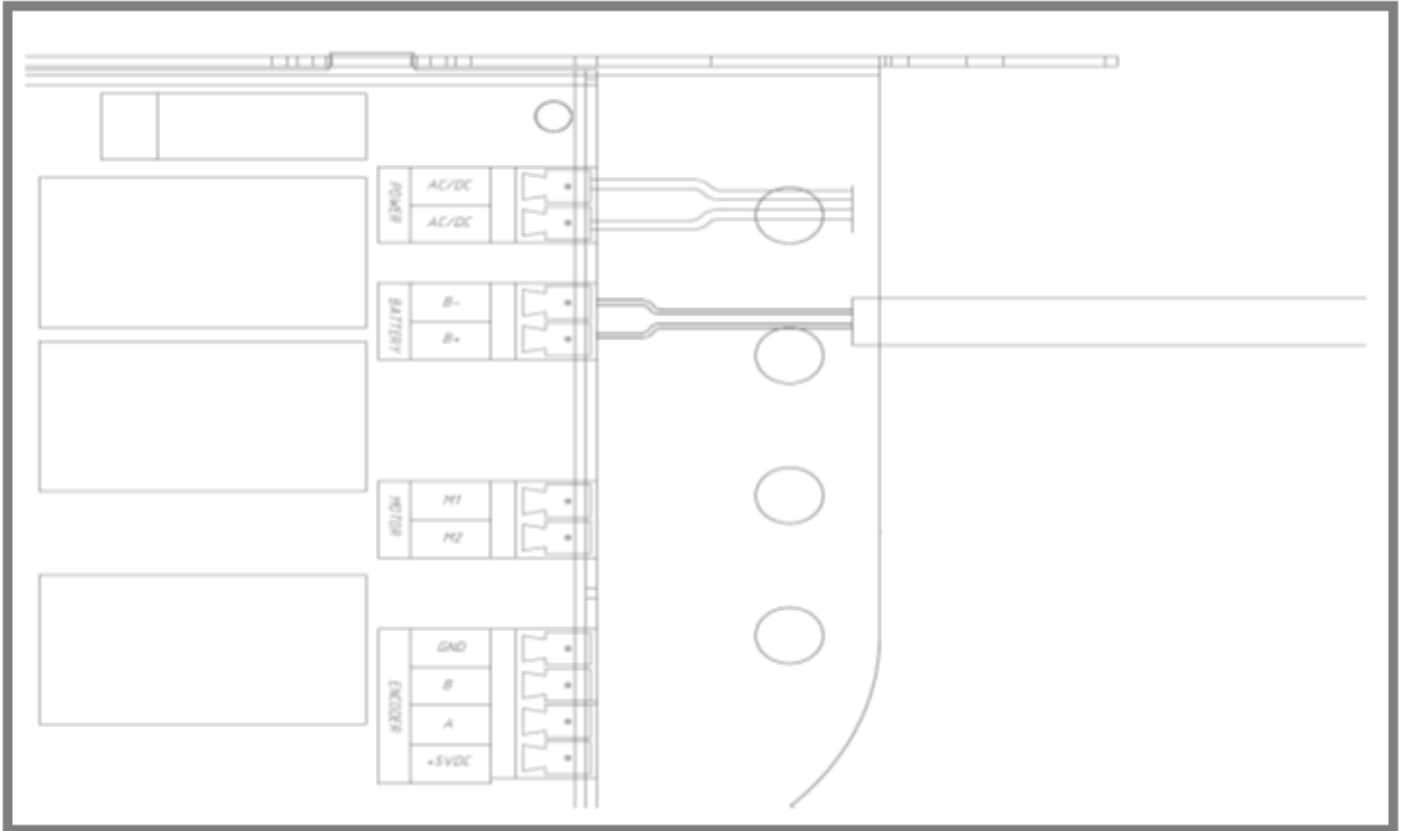
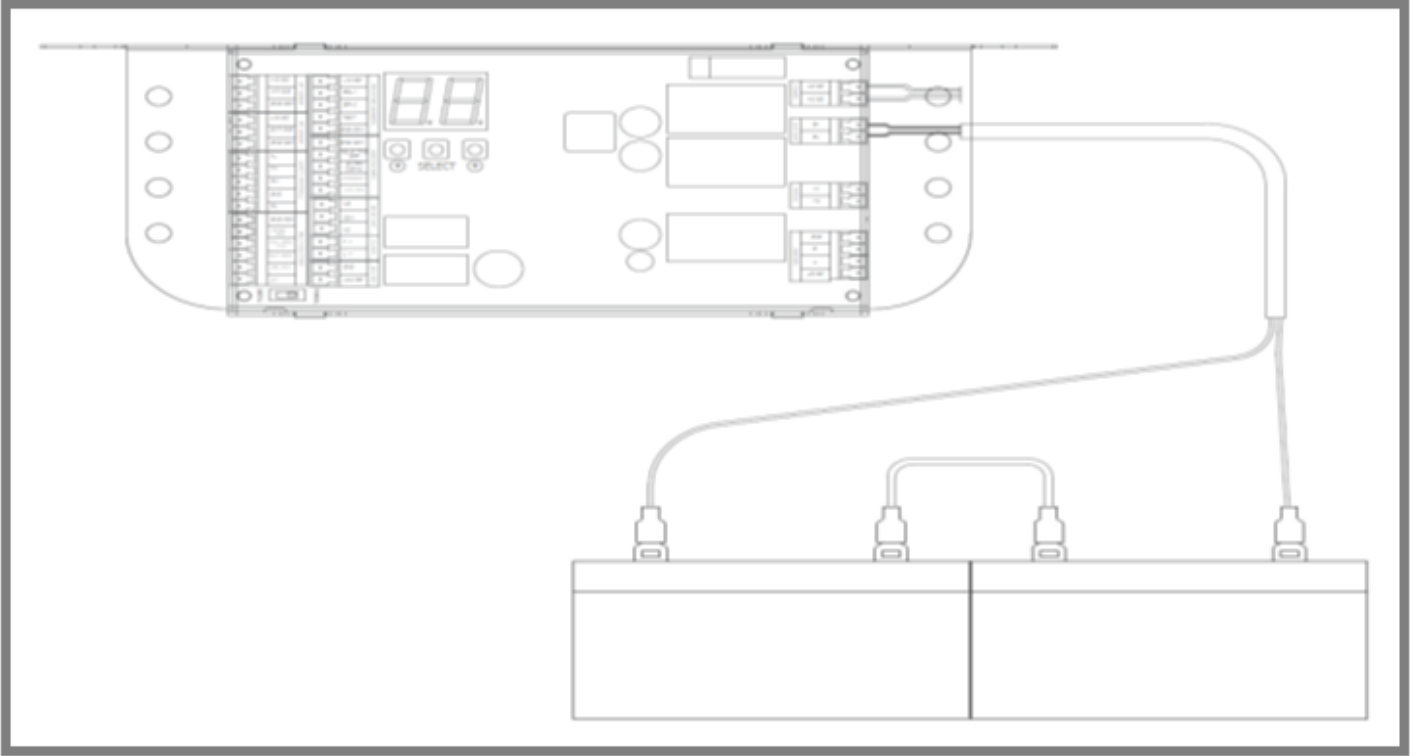

**İMAJ YAPI OTO.SİST.SAN VE TİC.LTD.ŞTİ.**

Tel. : 0212 270 00 44-45 - [www.exodoor.com.tr](http://www.exodoor.com.tr) – [info@exodoor.com.tr](mailto:info@exodoor.com.tr)

## ELECTRONIC LOCK CONNECTION

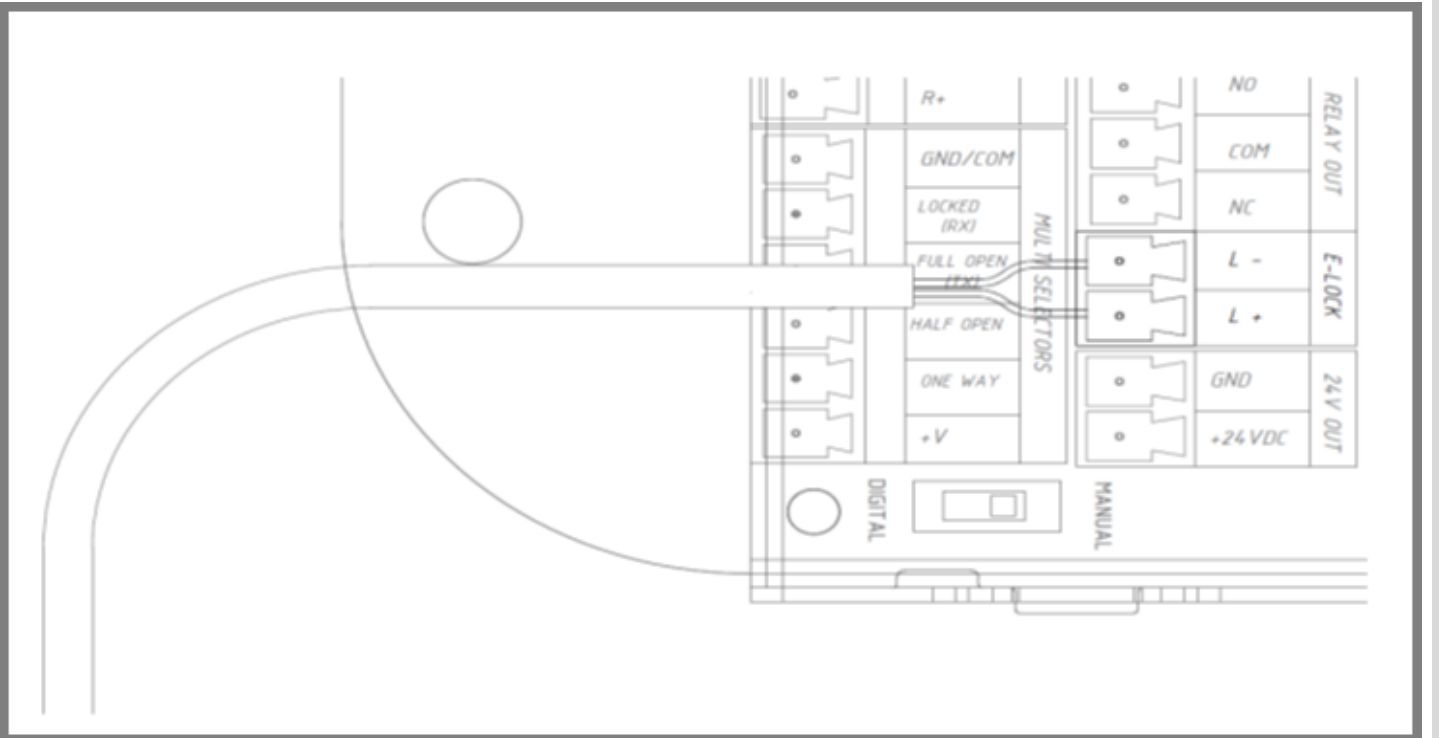
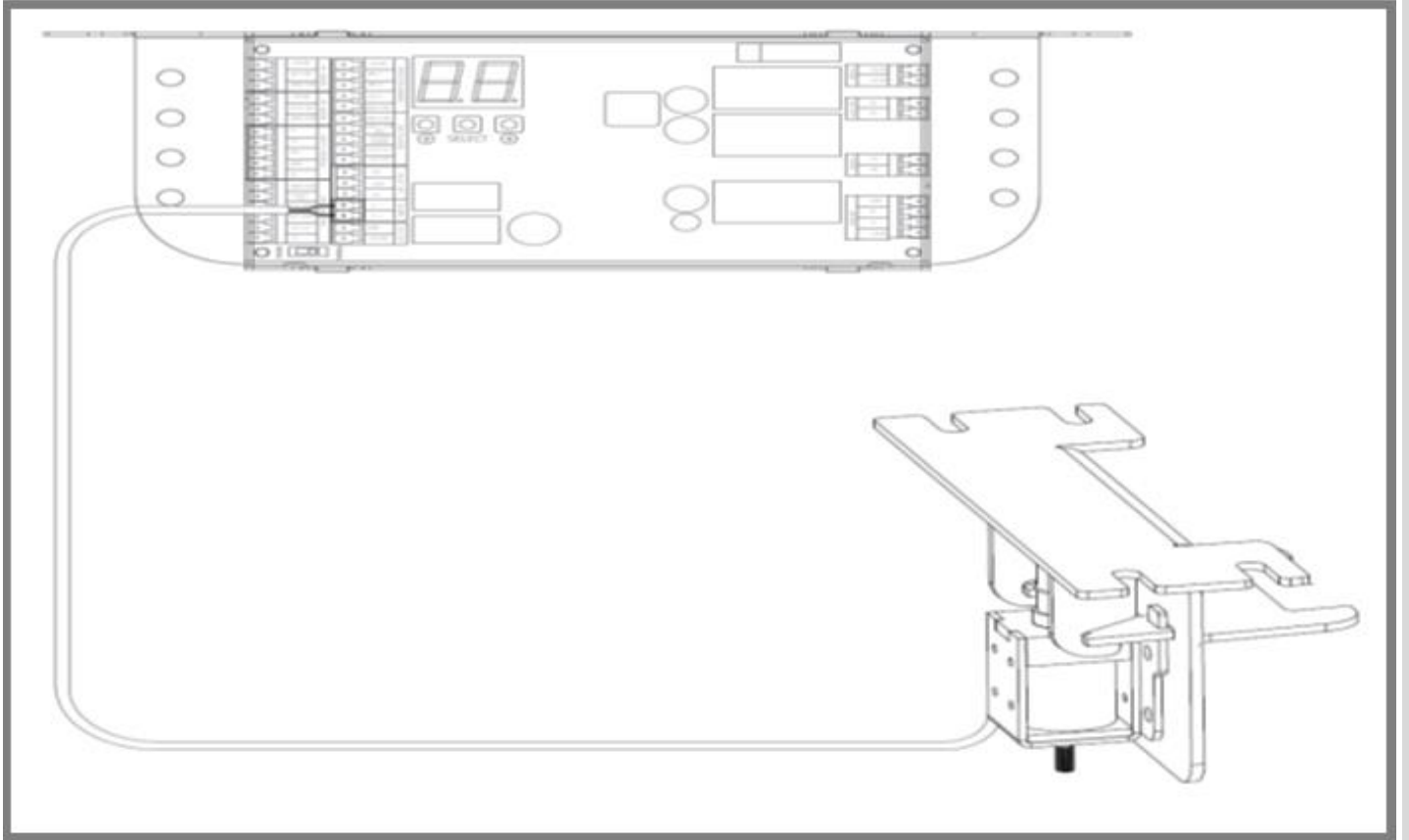

İMAJ YAPI OTO.SİST.SAN VE TİC.LTD.ŞTİ.

Tel. : 0212 270 00 44-45 - [www.exodoor.com.tr](http://www.exodoor.com.tr) - [info@exodoor.com.tr](mailto:info@exodoor.com.tr)

## KEY SWITCH CONNECTION

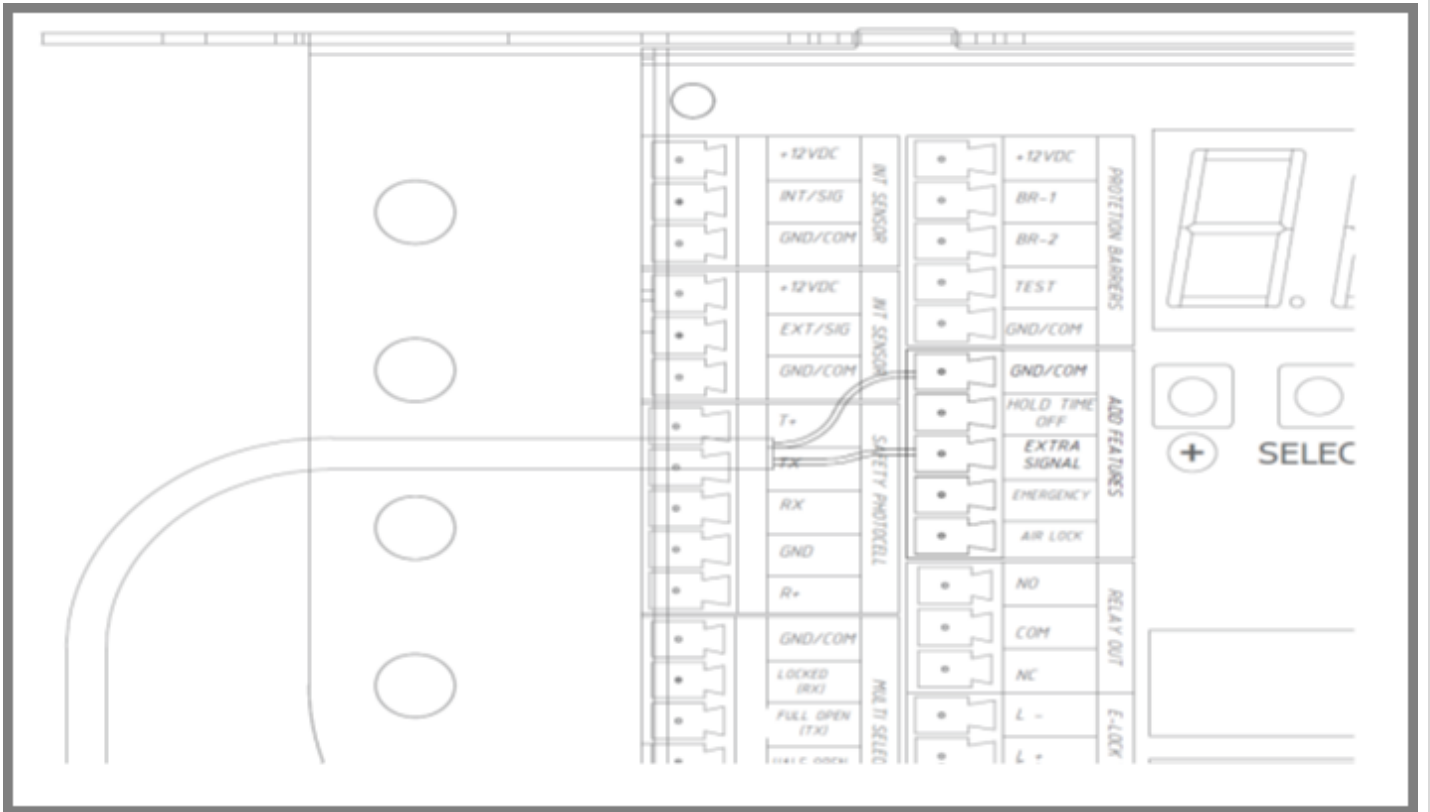
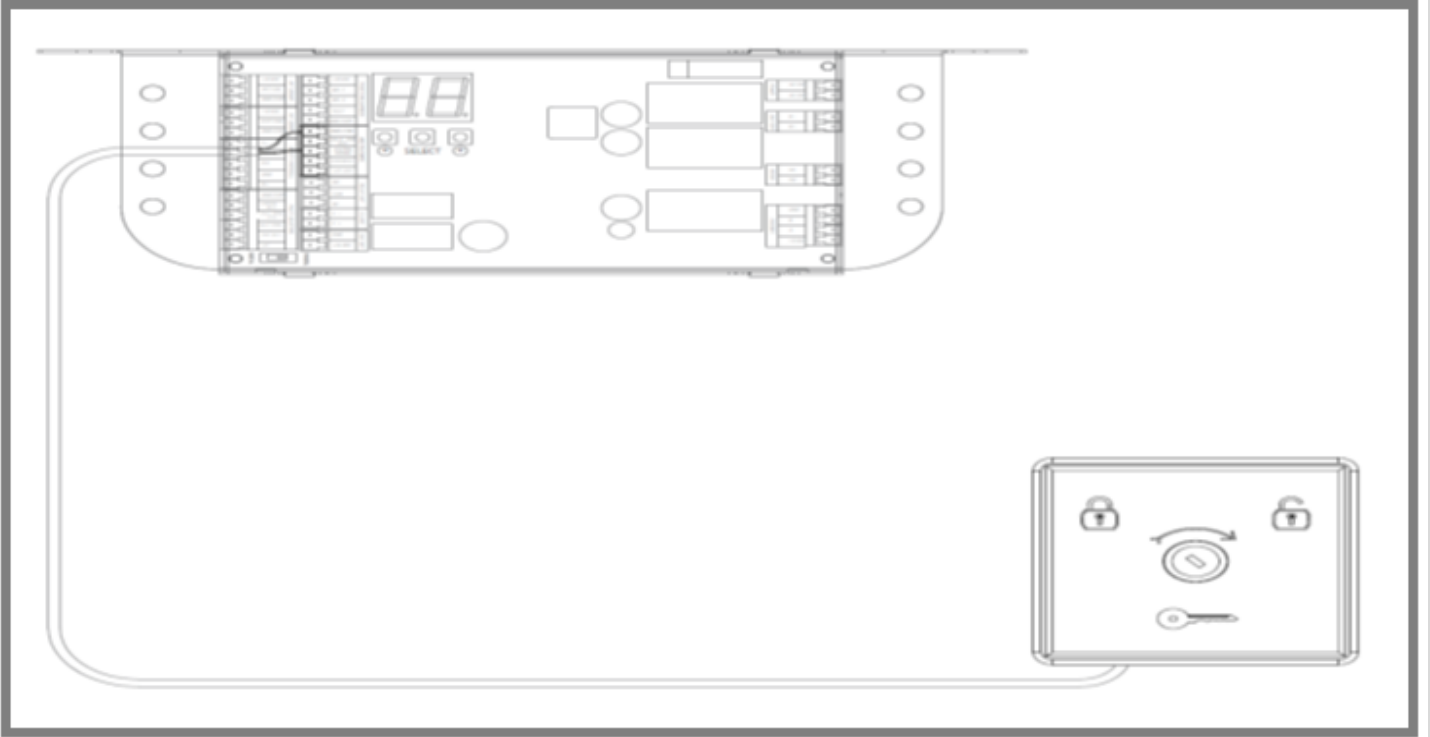

İMAJ YAPI OTO.SİST.SAN VE TİC.LTD.ŞTİ.

Tel. : 0212 270 00 44-45 - [www.exodoor.com.tr](http://www.exodoor.com.tr) - [info@exodoor.com.tr](mailto:info@exodoor.com.tr)

## EMERGENCY STOP BUTTON CONNECTION

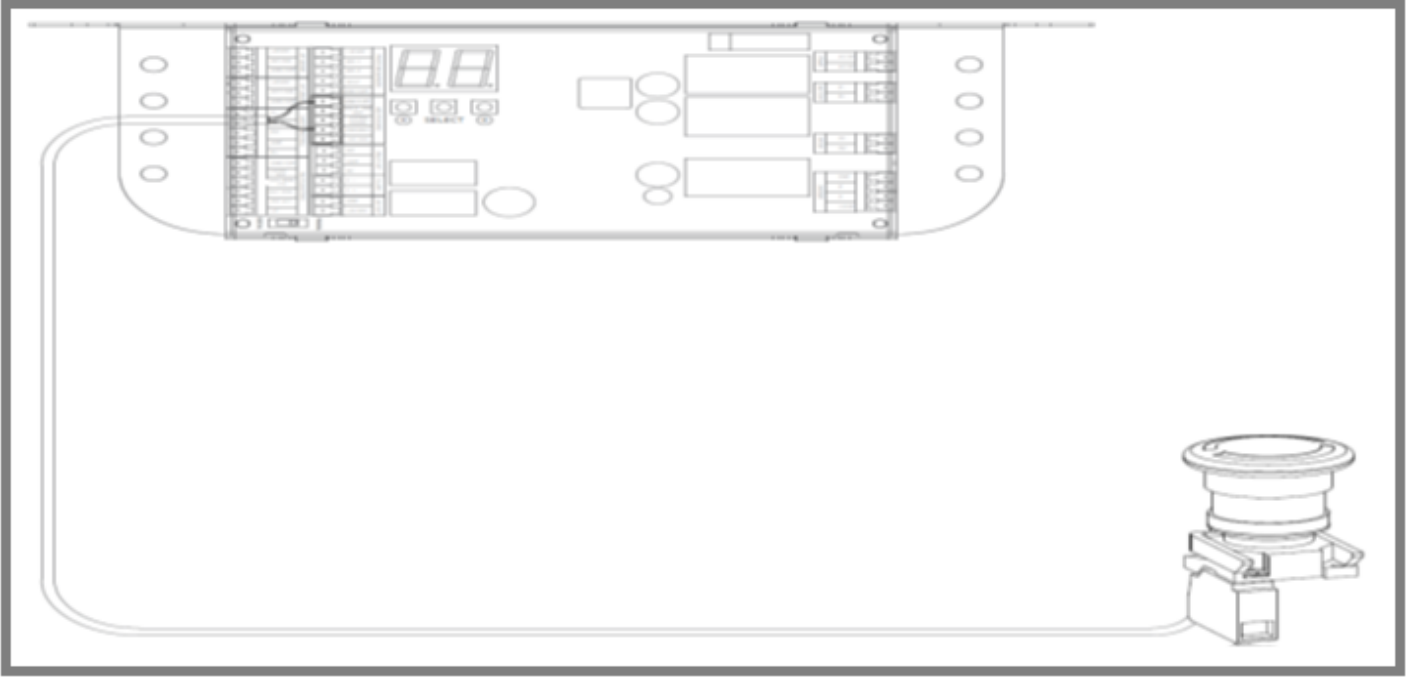

İMAJ YAPI OTO.SİST.SAN VE TİC.LTD.ŞTİ.

Tel. : 0212 270 00 44-45 - [www.exodoor.com.tr](http://www.exodoor.com.tr) - [info@exodoor.com.tr](mailto:info@exodoor.com.tr)

## SETUP

### **SETUP SCENARIO;**

Exodoor sliding door processor is equipped with user-friendly software. It is possible for even technicians who do not have much knowledge to operate the system easily. Procedures to be done before applying energy;

Before applying power, complete the mechanical assembly of the door as in the instructions.

Make sure that the electrical connections are made correctly.

If there is, put the mechanical position switch in the automatic entry and exit position.

Energize the system, the Exodoor sliding door system will start intelligent recognition.

### **DURING RECOGNITION;**

1: Encoder direction detection: It is corrected by software even if the encoder channels are connected in reverse.

2: Opening stop point: Maximum opening and resting on the stopper.

3: Closing stop point: Complete closing and joining of the wings.

4: Electronic lock test: If it is locked by closing pressure and then forced to open, it is understood that there is no lock in the system, if it is opened by 50 mm, then the lock is not checked when it is in the lock position. If it cannot be opened by 50 mm, it is understood that it is a lock system, and a check will be made in the next lock position.

5: Weight and slip test: It opens at a high speed of 50% of the measured distance and stops by braking at a safe distance.

6: Activator test: Safety systems are tested software-wise.

7: Saving to memory: When all learning conditions are met, it is saved to memory.

Settings such as the opening and closing speed of the door and the waiting time are given as default. It is possible to change them from the settings menu.

### **RE-LEARNING A PRE-LEARNED SYSTEM;**

If there is power, turn it off, re-energize it after the system is completely shut down, press and hold the selection (SELECT) button on the card within 2 seconds, release it after 3-4 seconds.

SETTINGS MADE HEREIN WILL NOT BE CHANGED.

TO RETURN ALL CHANGES MADE TO FACTORY SETTINGS, RESET TO FACTORY SETTINGS FROM THE SETTINGS MENU.

**İMAJ YAPI OTO.SİST.SAN VE TİC.LTD.ŞTİ.**

Tel. : 0212 270 00 44-45 - [www.exodoor.com.tr](http://www.exodoor.com.tr) – [info@exodoor.com.tr](mailto:info@exodoor.com.tr)

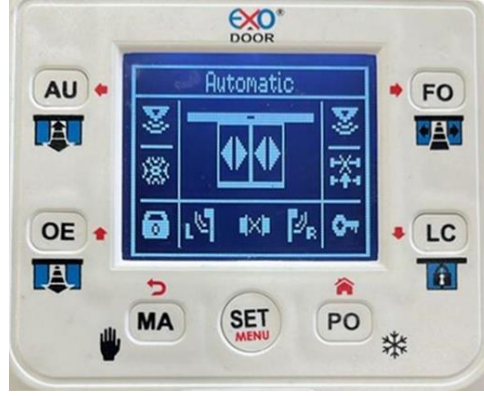

### **Automatic Working Mode:**

When in automatic operation mode, the abbreviation "Au" appears on the left side of the position switch. When the photocell door operates in automatic mode, both the Internal Radar and External Radar and the connected sensors function and the door can be opened. To activate this mode, simply press the Auto Mode Button.



### **Open Mode:**

When the photocell door is put into open mode, it will remain open continuously and the abbreviation "FO" will be seen on the left side of the position switch.



### **One Direction mode:**

If one-way mode is selected, the photocell door will only react to the signals coming from the Exit Sensor and will not process the signals coming from the Entry Sensor. This operating mode can be used when one-way traffic flow is desired. If OE One Direction mode is pressed for 2 seconds for the photocell door to switch to Entry direction mode, the photocell door will only react to the signals coming from the Entry Sensor and will not process the signals coming from the Exit Sensor. This operating mode can be used when one-way traffic flow is desired.



### **Locked Mode:**

If the locked mode is selected, the photocell door does not react to both Entry and Exit signals. However, if an external signal or emergency signal is given, the door will open. To switch to locked mode, the LC button must be pressed and released.

**İMAJ YAPI OTO.SİST.SAN VE TİC.LTD.ŞTİ.**

Tel. : 0212 270 00 44-45 - [www.exodoor.com.tr](http://www.exodoor.com.tr) – [info@exodoor.com.tr](mailto:info@exodoor.com.tr)





### Partial Opening Mode (Winter Mode):

In some cases, it may be desired to reduce the flow of hot or cold air in the indoor and outdoor environment by reducing the air circulation by opening the door less instead of opening it fully. In such cases, the opening of the door can be reduced by briefly pressing the Partial Opening Mode button. When partial opening mode is activated, the Snow Icon will light on the display on the position switch. Partial opening mode can be turned off by pressing the same button again. Partial Opening Mode can be used with other modes.



### Manual Mode:

It allows you to easily open and close the door manually during cleaning or when needed.



### Menu Mode:

Settings such as the opening and closing speed of the door and the waiting time are given as default. It is possible to change them from the settings menu.

**NOTE:** To enter the menu, press and hold the SET/MENU button for 2 seconds.

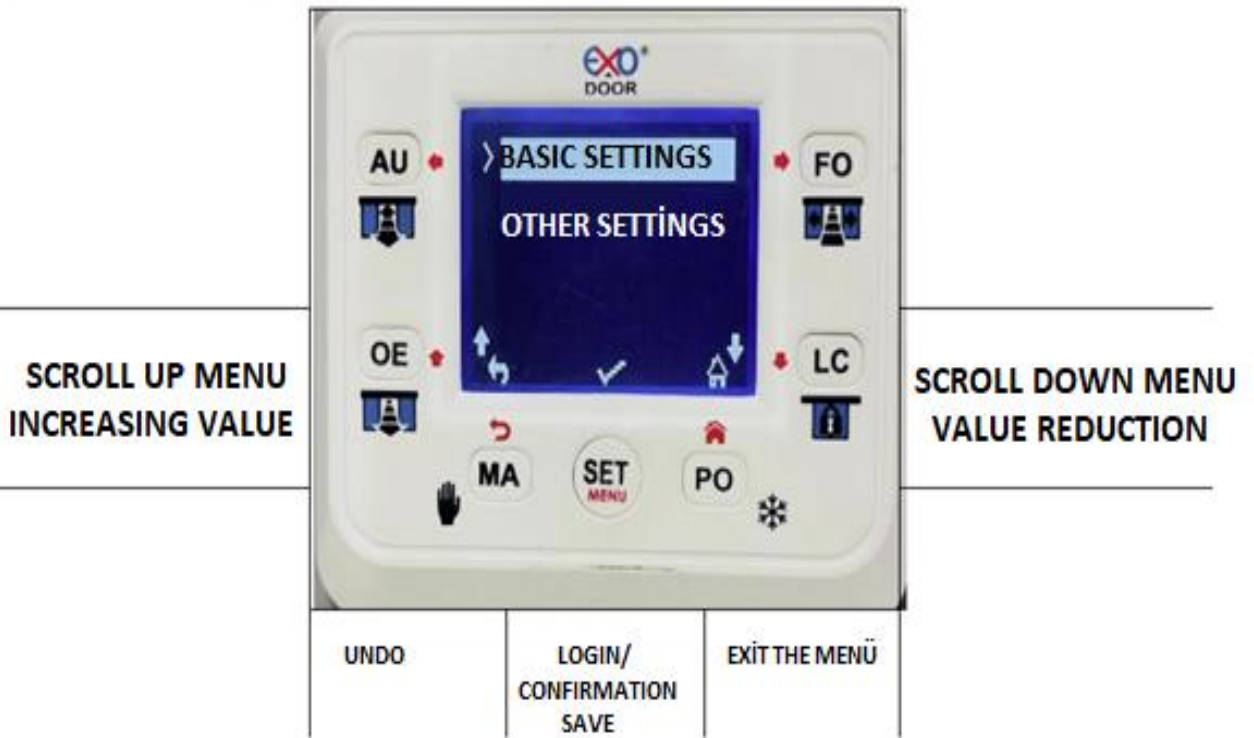

İMAJ YAPI OTO.SİST.SAN VE TİC.LTD.ŞTİ.

Tel. : 0212 270 00 44-45 - [www.exodoor.com.tr](http://www.exodoor.com.tr) – [info@exodoor.com.tr](mailto:info@exodoor.com.tr)

## LCD SCREEN PARAMETER SETTINGS

BASIC SETTINGS	SETTING RANGE	FACTORY SETTINGS
OPENING SPEED	03 -- 10	08
CLOSING SPEED	03 -- 10	06
ON COOLDOWN	00 -- 30	02
EXTRA SIGNAL DURATION	00 -- 30	02
WINTER MODE DISTANCE	03 -- 09	06
STEERING WHEEL	00 -- 01	00

OTHER SETTINGS	SETTING RANGE	FACTORY SETTINGS
INTERNAL PHOTOCCELL	00 -- 01	01
BATTERY	00 -- 01	01
LOCK TYPE	00 -- 01	00
LOCK MODE	00 -- 02	00
PRESS ON/OFF MODE	00 -- 03	00
EXTERNAL PHOTOCCELL	00 -- 02	00
HERMETIC MODE	00 -- 01	00
ROLE TASK	00 -- 01	00
EMERGENCY DUTY	00 -- 05	00
SENSOR TEST ON/OFF	00 -- 01	00
ENGINE LOCK ON/OFF	00 -- 01	00
FACTORY SETTINGS	00 -- 01	00
CALIBRATION	00 -- 01	00
LANGUAGE	00 -- 01	00

İMAJ YAPI OTO.SİST.SAN VE TİC.LTD.ŞTİ.

Tel. : 0212 270 00 44-45 - [www.exodoor.com.tr](http://www.exodoor.com.tr) – [info@exodoor.com.tr](mailto:info@exodoor.com.tr)

## PARAMETER SETTINGS

Parameter Order		Parameter Description	Default Value	Minimum Value	Maximum Value
0	EE	Exit Settings			
1	OP	Opening Speed	08	03	10
2	CL	Closing Speed	05	03	08
3	OT	Open Cooldown	02	00	30
4	OL	Waiting Time After Extra Signal Input	05	00	30
5	HO	Partial Opening Percentage	60	10	90
6	DR	Engine Direction Steering	00	00	01
7	NE	Go to Next Menu			

### OPTIONAL SETTINGS:

Parameter Order		Parameter Description	Default Value	Minimum Value	Maximum Value
0	EE	Return to Previous Menu	01		
1	PH	Photocell Activation	00		
2	BT	Battery Activation	00		
3	LT	Electronic Lock Type	00		
4	LC	Electronic Lock Operation Settings	00		
5	PP	Push-On-Push-Off Setting	00		
6	HH	Hermetic Mode On and Off	00		
7	EN	EN16005 Mode Activation	00		
8	BR	Activating Barrier Photocell	00		
9	MA	Location Switch Input Settings	00		
10	FA	Factory settings	00		
11	LE	Door Learning Start	00		

### DIGITAL POSITION SWITCH FEATURES:

**Salutation: Company Logo**

**Main Screen: Door Locations and Signal Tracking**

**Error Screen: Error Code and Description**

**Setting Menu:**

### LEARNING STEPS:

- 1:) Unlocked if available
- 2:) If the Encoder Connection is Reverse, It is Corrected
- 3:) Opening Point is Found
- 4:) Find the Correct Distance to the Closing Direction
- 5:) Lock is Tested and Detected, If Any, When Closed
- 6:) Weight Test is Performed in the Opening Direction
- 7:) All is Memorized and Learning is Over..

**İMAJ YAPI OTO.SİST.SAN VE TİC.LTD.ŞTİ.**

Tel. : 0212 270 00 44-45 - [www.exodoor.com.tr](http://www.exodoor.com.tr) – [info@exodoor.com.tr](mailto:info@exodoor.com.tr)