

EXODOOR AUTOMATIC REVOLVING DOOR

AUTOMATIC REVOLVING DOOR USER MANUEL and INSTALLATION GUIDE

EXODOOR, automatic revolving door system completes your building in technicaly and architecturally with its energy efficiency, isolating capacity of noise, temp and dirt by combine stylish apperance.

İMAJ YAPI OTOMASYON SİSTEMLERİ SAN VE TİC LTD.ŞTİ.
01.01.2024

İMAJ YAPI OTO.SİST.SAN VE TİC.LTD.ŞTİ.

Seyrantepe Mh. İbrahim Karaođlanođlu Cd.No:55 P.K:34418

KAĐITHANE / İSTANBUL

Tel. : 0212 270 00 44-45

Faks : 0212 270 44 11

www.exodoor.com.tr / info@exodoor.com.tr





CONTENTS

1. INTRODUCTION

2. TECHNICAL SPECIFICATIONS

3. SIZES

4. INSTALLATION

5. GENERAL SETTINGS

6. FAULT CODES

INTRODUCTION

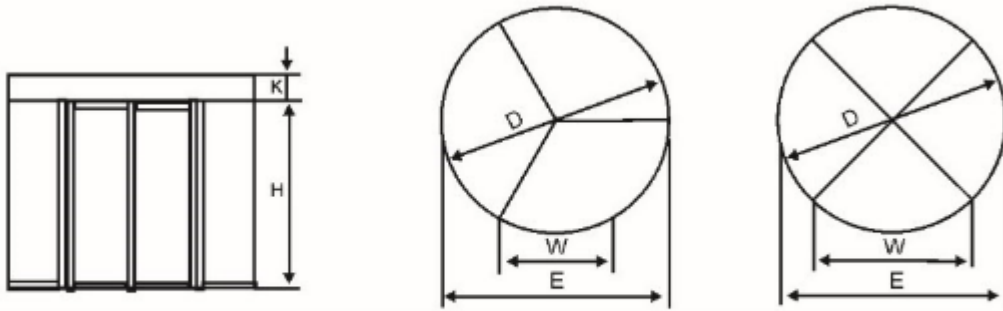

D: Canopy External Diameter D1: Internal Diameter W: Passing Width H: Passing Height K: Canopy

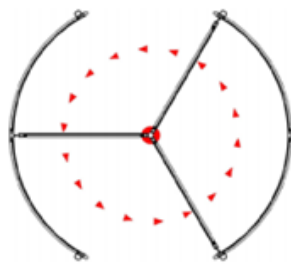

3 Wing Application

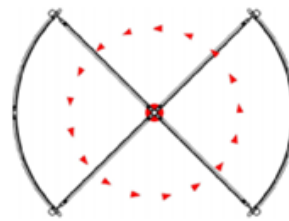

4 Wing Application

EXODOOR AUTOMATIC REVOLVING DOOR



2. TECHNICAL SPECIFICATIONS

Technical Specifications	Explanation
Feed Input	220-230 Vac 50hz 16a(Single Phase)
Motor and Reducer	0,25KW, 220VAC 3 Phase, Aynamahruti Reducer (Bonfiglioli, Italy)
Engine Driver	0,4KW 220-230VAC 50-60 Hz Frequency Control Unit (EXODOOR, Türkiye)
Activator Feed	110-240VAC 24V 5A Switchmode (Omron, Japan)
System Controller	Industrial PLC (EXODOOR, Türkiye)
Remote Control	Industrial HMI Touch Screen (EXODOOR, Türkiye)
Readers	4 mm Metal Sensitive Sensor (Omron, Japan)
Pneumatic Safety	EPDM Profiled Security Border (Aso, Germany)
Photocell Safety	Safety Light Curtain with Passive Infrared Sensor (Bircher/Reglomat, Switzerland)
Perception	Microwave Radar 24 Ghz (EXODOOR, Türkiye)
Buttons	Touch Button Membrane Safety (EXODOOR, Türkiye)
Lighting	220VAC 5W 6/8 Piece LED Spot (P.R.C)
Locking	Locking from Electromagnetic Current Printed Motor (EXODOOR, Türkiye)
Canopy Construction	30x30 2mm Twisted Galvanized Steel Profile
Forehead Veneer	Coated 2mm Twisted Aluminum Sheet
Ceiling Covering	CNC Cutting 2mm Modular Ceiling System
Middle Shaft	Aluminum Sigma Profile with 3/4 Wing Option
Center Bearing	Special Oil Impregnated Vertical Carrier Derlin, Not Affected by Water and Dust.
Twisted Aluminum Profiles	EXODOOR Patented Jointless Slatless Interlocking Series with Bending Suitable Design.
Cheek Curved Glasses	8mm Tempered or 4+4 Laminated Transparent Curved Glass Specially Produced for the Door.
Aluminum Wing Profiles	EXODOOR Patented Brush Cover, Wrapping-Free, Slatless Series.
Wing Windows	Custom Made 8mm Tempered or 4+4 Laminated Transparent Flat Glass, Depending on the Door.
Brushes	45mm Horsehair Brush that does not make noise or scratches.

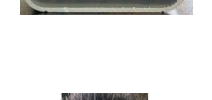
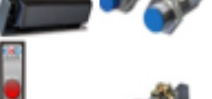

Optional Features	Explanation
Presence Sensors	It is recommended to be used on doors with an outer diameter larger than 2800 mm.
On-Wing Presence Sensors.	It is recommended to be used on doors with an outer diameter of 3800 mm and above. .
Broken Wing (Break out)	It must be used in places where there is no service door.
Automatic Night Shield	Single or Double Wing Automatic Circular Door Synchronized with the Door.
Air curtain	Straight or Curved Air Curtain System Synchronized with the Door.
Stainless Coating	304 or 316 Quality Polished, Satin or Special Patterned Stainless Plate.
Colored Glass-Special Glass	Plain or Reflective Options on Cheeks and Wings.
Wing Arms	Vertical or Horizontal Stainless or Aluminum Pipe Arms.
Night Shield	Circular Sliding Door with Automatic and Manual Locking.



TOUCH SCREEN (HMI)

SELECTION



POSITIONS



SYSTEM MONITORING



SETTINGS



ERROR NOTIFICATIONS

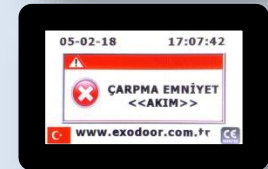

The **PLC CONTROLLER** with a special MAC address allows remote access through the necessary settings and PORT forwarding.

Also, since HMI is able to see temporary or permanent error Codes on the screen, without hassle for fault detection,

According to the Error Code on the screen without losing time is resolved.

BONFIGLIOLI MOTOR (ITALY) TECHNICAL SPECIFICATIONS;

Torque range

100 ... 14000 Nm

Mechanical rating ($n_1 = 1400 \text{ min}^{-1}$)

0.22 ... 150 kW

Gear ratios

5.4 ... 1715

Output

Foot and shaft mount - two bore options per size

Keyless shrink disc fitting

Metric or Inch series solid output shaft

Taper bushings matching more shaft diameters

Splined hollow shaft to DIN 5480

Input

IEC and NEMA motor adaptors

Servomotor adapters

Metric or inch series solid input shaft

Main gear options

Backstop

Reinforced bearings for higher overhung load capacity

Reduced backlash

Taconite seals

Applicable AC motors

Integral motors and brake motors - M series / ME series

IEC-normalized motors and brake motors - BN series / BE series

Single and dual speed motors

Main brake features

DC and AC supply

Faster brake engage/disengage through electronically

Controlled AC/DC rectifier type SB, NBR, SBR (options)

Main motor options

Thermistors and thermostat sensors

Separate supply forced ventilation

Line driver and push-pull incremental encoder

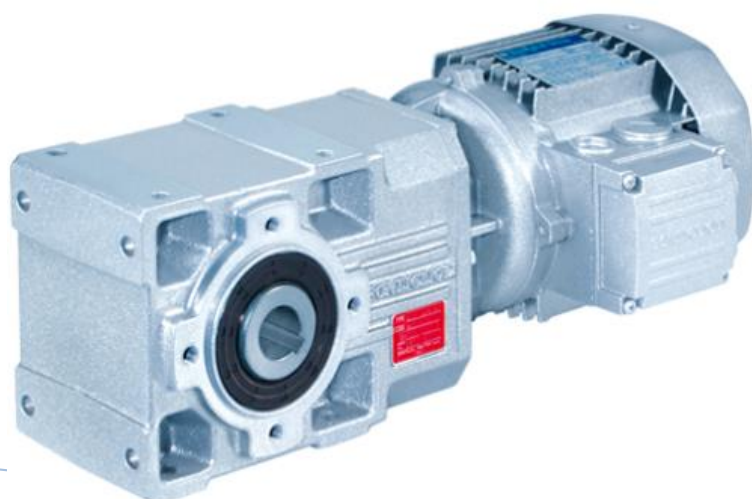

Type	Torque [Nm]
A 05	100
A 10	150
A 20	250
A 30	410
A 35	600
A 41	850
A 50	1500
A 55	2000
A 60	2800
A 70	5000
A 80	8000
A 90	14000

3. SIZES

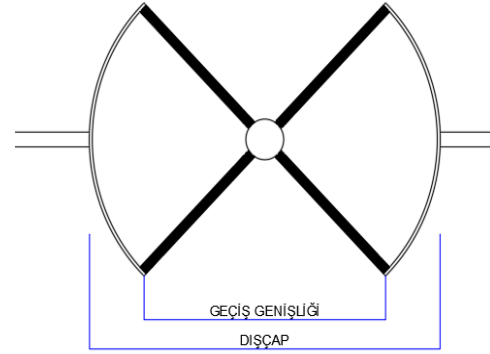
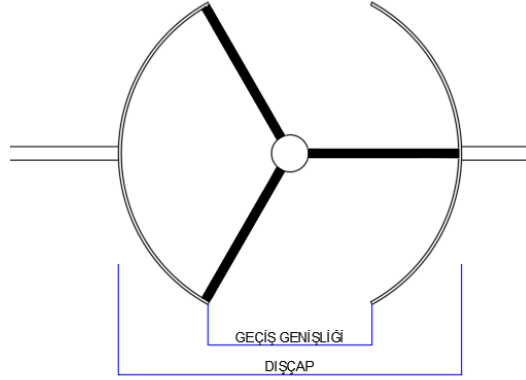
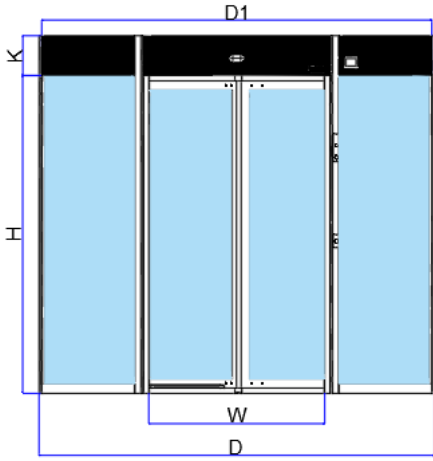

D: Canopy External Diameter

D1: Internal Diameter

W: Passing Height

H: Passing Height

K: Canopy

D	D1	W/3	W/4	H	K
2000	1895	912	1326	2100 - 2200	200 - 1000
2100	1895	962	1397		
2200	1995	1012	1468		
2300	2095	1062	1539		
2400	2195	1112	1610		
2500	2295	1162	1681		
2600	2395	1212	1752		
2700	2495	1262	1823		
2800	2595	1312	1894		
2900	2195	1362	1965		
3000	2295	1412	2036		
3100	2395	1462	2107		
3200	2495	2512	2178		
3300	2595	1562	2249		
3400	1995	1612	2320		
3500	2095	1662	2391		
3600	2195	1712	2462		
3700	2295	1762	2533		
3800	2395	1812	2604		
3900	2495	1862	2675		
4000	2595	1912	2746		

* All sizes are in mm.

* All sizes can be changeable according to project.

* On demand sizes is available.

4. INSTALLATION

A. REQUIRED TOOLS;

1. Driller (battery powered recommended)
2. Screwdriver, socket wrench (battery powered recommended)
3. Marker (or pencil)
4. Silicon and gun
5. Leveler

B. PREPARING THE INSTALLATION;

1. Check the sizes and ground level before the installation.
2. Level out the roughness on installation ground.
3. Clean the installation ground.

C. THE INSTALLATION;

- C.1. Ground drawing and installation;
- C.2. Installation of canopy and strut profiles;
- C.3. Assemble of skirt profiles;
- C.4. Curved Glasses;
- C.5. Ceiling Sheets;
- C.6. Middle Strut;
- C.7. Assemble of Door Leafs Handles;
- C.8. Siliconing and Door Operation Control,

THE PRODUCT IS DELIVERED BY
PERFORMING OPERATIONAL CONTROL.

EXODOOR AUTOMATIC REVOLVING DOOR

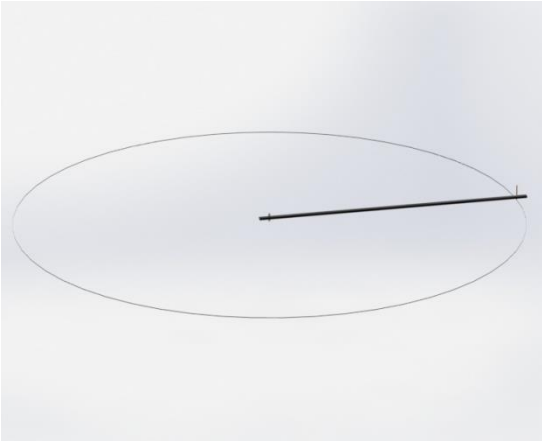

Ground drawing



Installation of strut profiles



Skirt profiles top view



Mounting of the Central Record Profile



Strut Mounting

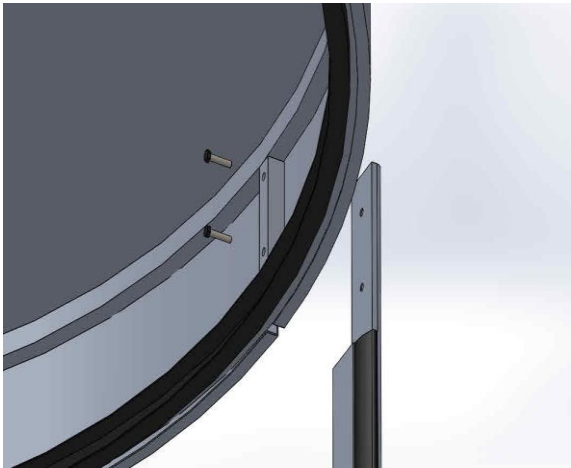

Make The Connection To The Canopy,

EXODOOR AUTOMATIC REVOLVING DOOR



Mounting to Floor and Boots



Mounting of Dished



Central Carrier Mounting



Middle Shaft Mounting



Wing Mounting

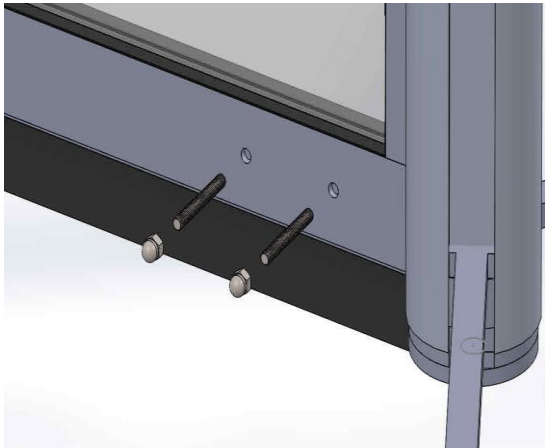

Shaft Connection to Wings.

EXODOOR AUTOMATIC REVOLVING DOOR

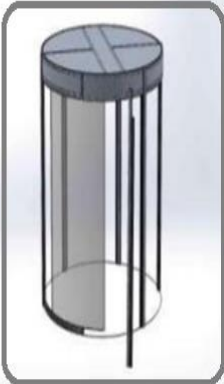
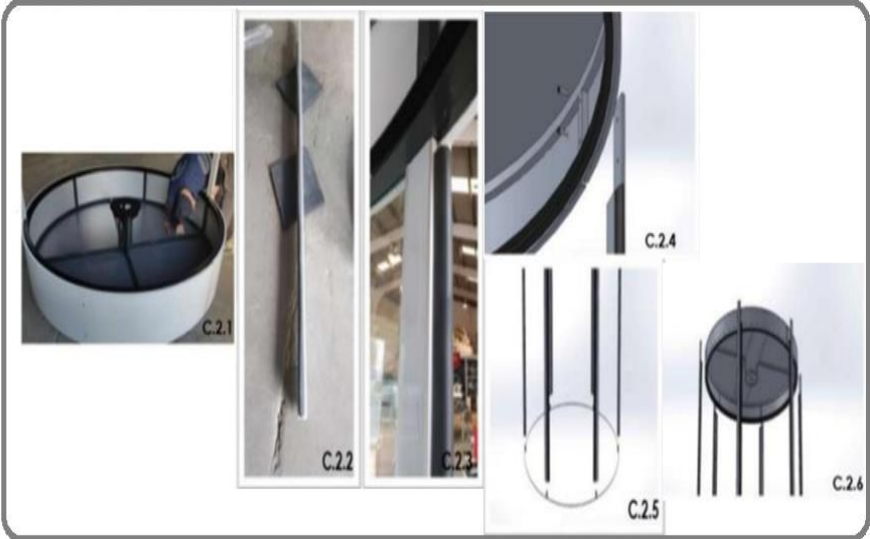
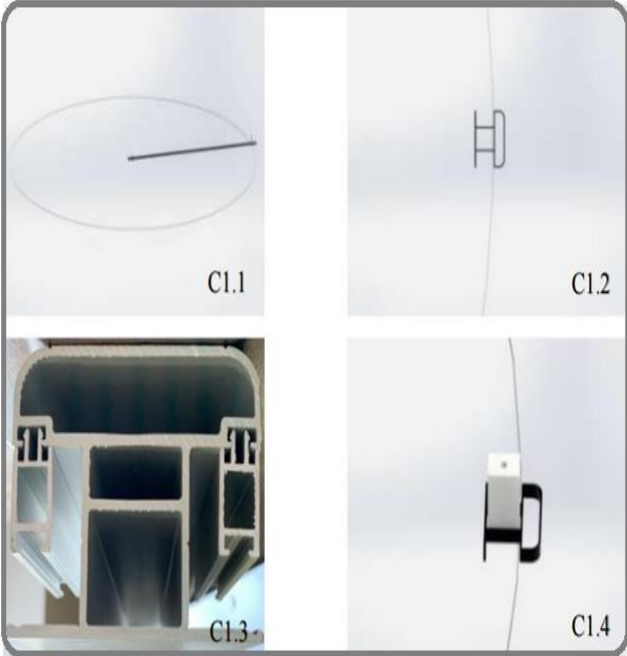

5. GENERAL SETTINGS

D. LCD PANEL USAGE AND SETTINGS;

The LCD panel is a touchscreen digital display with a user-friendly interface that shows you status of door and allows you to set general settings. You can make basic settings using the LCD panel.

The **PLC CONTROLLER** with a special MAC address allows remote access through the necessary settings and PORT forwarding.

Also, since HMI is able to see temporary or permanent error Codes on the screen, without hassle for fault detection,

According to the Error Code on the screen without losing time is resolved.

D.2 General settings;

D.2.1 Position Settings;



EXODOOR AUTOMATIC REVOLVING DOOR

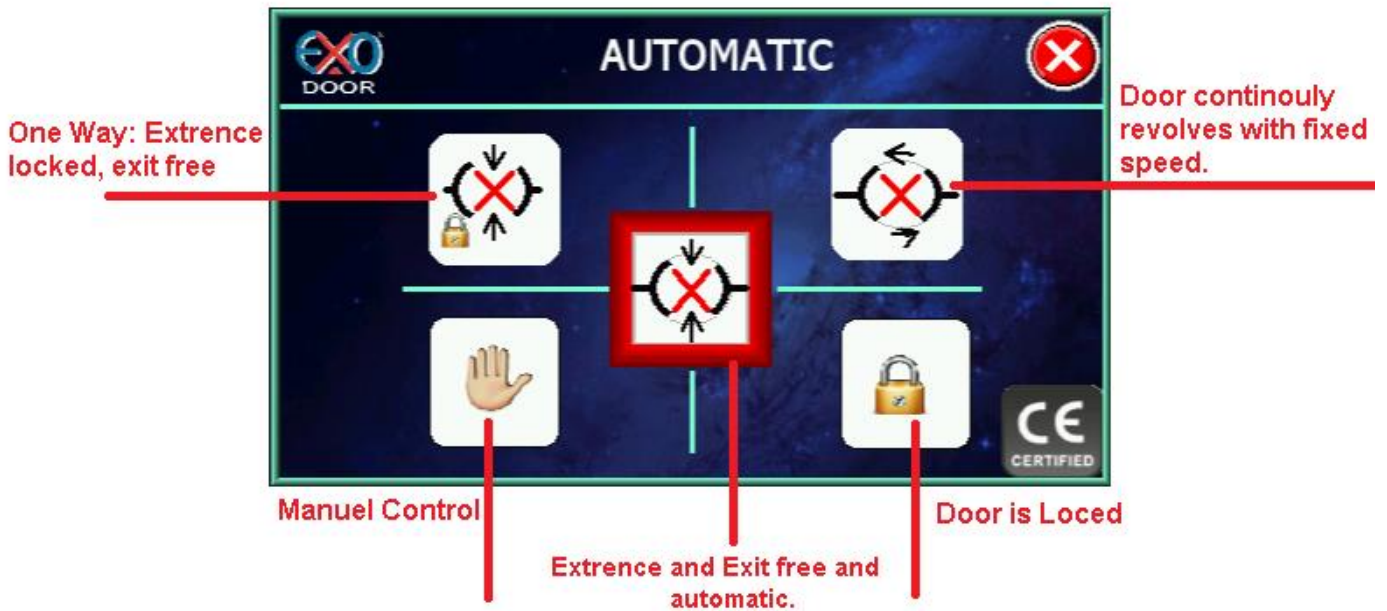

D.2.2 System Monitoring;

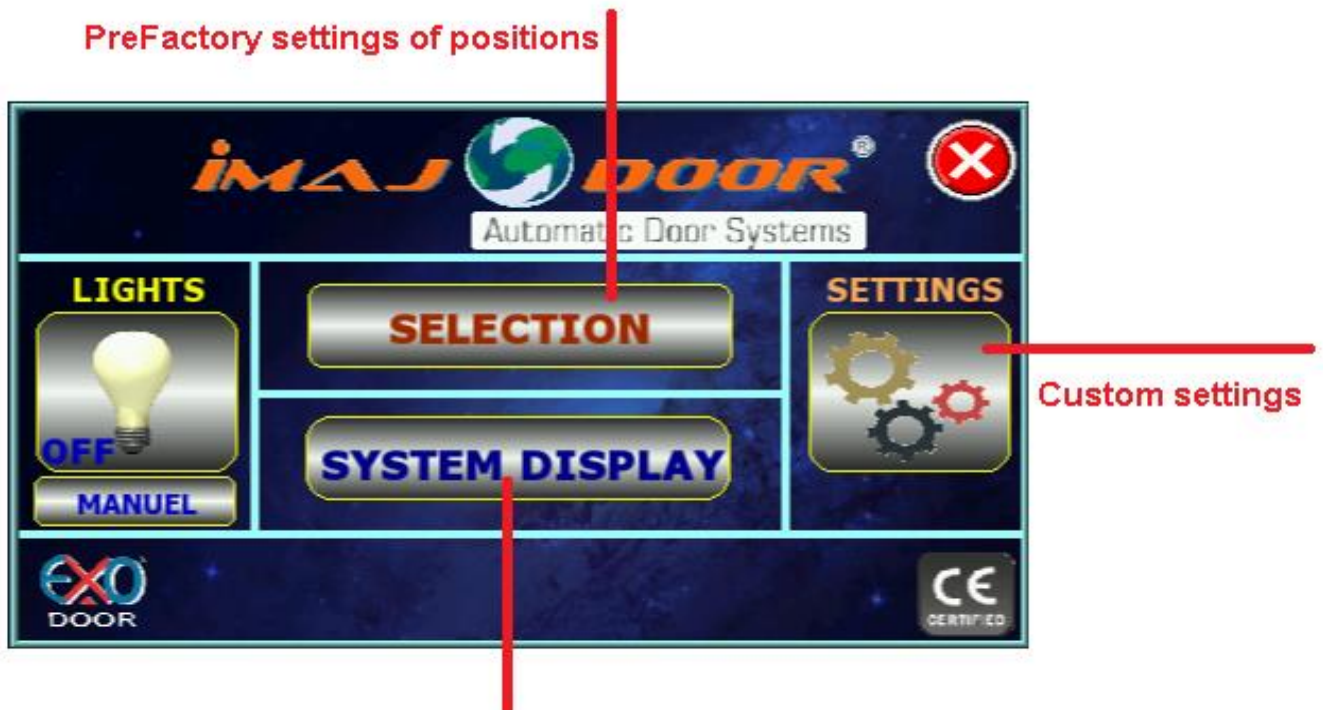

This feature allows to check every Electronical component located on door such as photocells, sensor etc.

EXODOOR AUTOMATIC REVOLVING DOOR



Green: Active

Red: Inactive

D.2.3 Settings;

Enter the password to enter the settings,

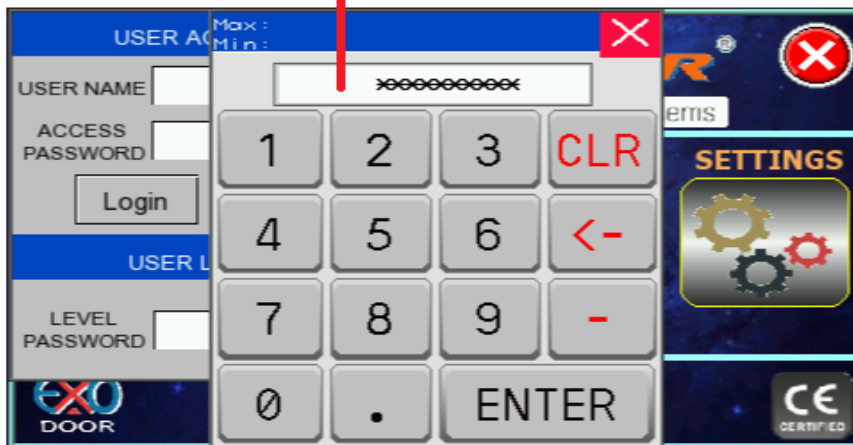

Selection of number of leaves

These settings are accessible only for company authorized people

EXODOOR AUTOMATIC REVOLVING DOOR

SLOW SPEED: Slow speed of the door before it starts moving.

HANDICAPPED SPEED: Slow speed for the handicappeds.

NORMAL SPEED: Normal movement speed.

JOG ACC. SPEED: Acceleration speed for the door's first movement.

JOG SLOW SPEED: Set speed of the door stops.

CURRENT LIMIT: Current multiplier; this setting shouldn't be changed with unauthorized.

CURRENT READ: Instantaneous value of current multiplier.

LOCK TIME: Duration of the door detects jumbling.

SAFE STOP TIME: Duration from stationary position to moving position.

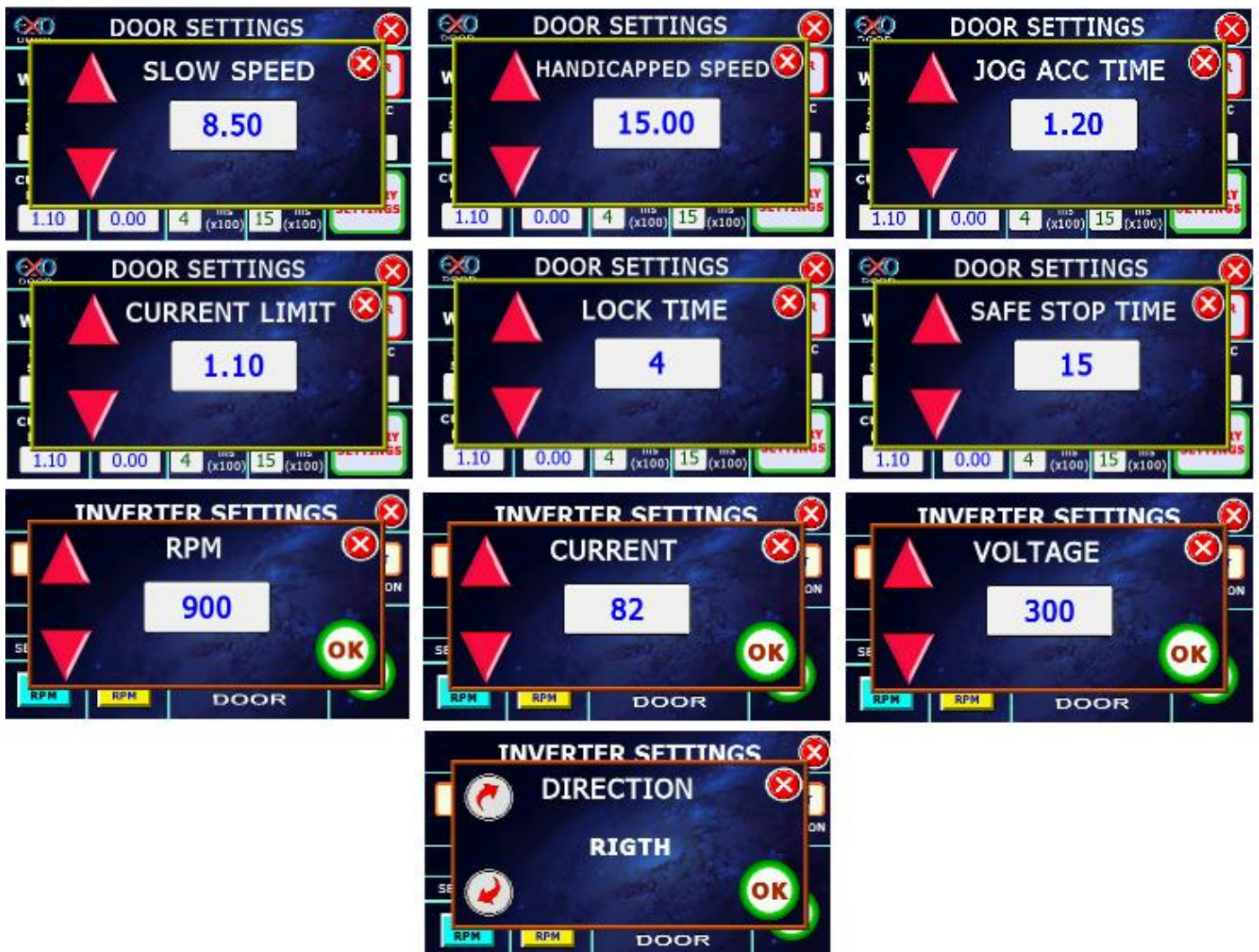

6. FAULT CODES



İMAJ YAPI OTO.SİST.SAN VE TİC.LTD.ŞTİ.

Seyrantepe Mh. İbrahim Karaođlanođlu Cd.No:55 P.K:34418

KAĐITHANE / İSTANBUL

Tel. : 0212 270 00 44-45

Faks : 0212 270 44 11

www.exodoor.com.tr / info@exodoor.com.tr